

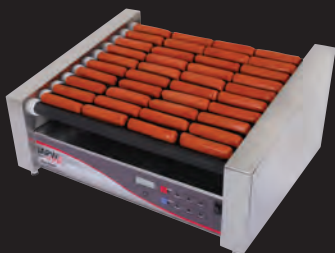

DESIGNED SMART. BUILT SOLID.®

FOOD SERVICE EQUIPMENT

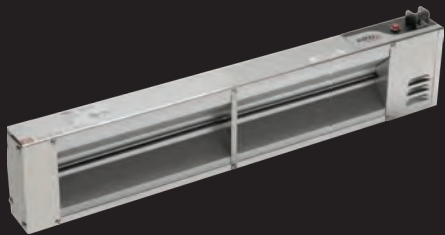

2017 Product Guide & Price List

Effective 1.4.2017

Champion COOKLINE

COOK SERIES



POWER

- One of the highest BTU ratings in its class delivers more power to the pan
- Reduces amount of labor time to cook a ¼ pound hamburger up to 20%
- Fast start-up and recovery to prime cooking temperatures

CONTROL

- Versatile grate system can be adjusted in height to give maximum control
- Front panel openings enable easy pilot lighting without panel removal
- Infinite adjustable gas valves turn 180 degrees to produce the perfect amount of heat for all menu needs
- Field convertible and adjustable gas regulator

SAFETY

- Double walled firebox protects control panel from higher temperatures
- Bull-nose front extension protects employees from burns
- Maintenance is safer and easier with bottom-mount grease collection pan and removable top grates

Learn more on page 1



Designed Smart. Built Solid.®

Customer Service

(800) 527-2100

Place an Order

ordereast@standexcsg.com

orderwest@standexcsg.com

ordercentral@standexcsg.com

orderinternational@standexcsg.com

ordernational@standexcsg.com

Questions

Central@standexcsg.com

Western@standexcsg.com

Eastern@standexcsg.com

International@standexcsg.com

National@standexcsg.com

24-Hour Service

(800) 733-2203 Hotline

servicegroup@standex.com

Replacement Parts

parts2@standex.com

Literature Request

literature@standex.com

Corporate Offices

APW Wyott

Food Service Equipment Company

1307 N. Watters Road, Suite 180

Allen, TX 75013

Local (972) 908-6100

Toll Free (800) 527-2100

Fax (214) 565-0976

www.apwwyott.com

Champion Series	1
CharBroilers	1
Griddles	2
Hot Plates	3
Induction	5
CheeseMelters	6
Fryers	6
Countertop Deck Ovens	7
Equipment Stands & Accessories	8
Steam Tables & Accessories	9
HD Cookline Series	14
Toaster Series	17
Classic Insulated Warmer Series	20
Classic Warmer Series	24
X*PERT™ Roller Grill Series	26
Concession Series	30
Merchandiser Series	33
Food Wells Series	34
Overhead Warmer Series	44
X*PERT™ Holding Drawer Series	61
Lowerator® Series	63

The electrical and dimensional information supplied is for reference purposes only.
APW Wyott reserves the right to modify specifications or discontinue models without incurring obligation.



APW Wyott Quick Ship Program

APW Wyott's Quick Ship Program is the fastest way to ship our top selling cooking, food warming, and toasting equipment directly from our warehouse to your operation. The equipment will leave our warehouse within two shipping days after you place your order.

Items in the Product Guide highlighted in red are quick ship items or "A" items.

Order on Quick Ship products sent in by 12:00 p.m. (Noon) Central Time will be shipped within the next two days. (Received on Monday... will go out by that Wednesday or sooner)

Cookline

EG-36i 208-240V
GCRB-24i Standing Pilot

Concessions

BC-31
BC-50
BW-50 120V
HR-20 120V
HRS-31S 120V
HRS-45 120V
HRS-50 120V
HRS-50S 120V
RTR-4 120V
RTR-8 120V
SG-31
SG-50
SG-50XP
SPTU-50 120

Holding Drawers

HDDi-1 120V
HDDi-2 120V
HDDi-2B 120V
HDDi-3 120V

Hot Wells

BM-80CD 208/240V
BM-80D 208/240/277V
BM-80D W/DR 208/240V
BM-80D Well/DR 36UL
CFW-1D COLD PAN W/D
CW-1 COLDWELL 120V
CW-5 COLDWELL 120V
HFW-1D 120V
HFW-1D 208/240V
HFW-2D W/DR 208/240
HFW-3D W/DR 208/240
HFW-4D W/DR 208/240
HFW-5D W/DR 208/240
SM-50-11D UL W/DR 120V
TM-90D UL W/DR
208/240V
TM-90D W/DR 120V
TM-90D W/DR 208/240V
TM-90UL 36UL 120V

Lowerators

HML2-10 110V

Overhead Warmers

FD-24H 120V Toggle
FD-36H 120V Infinite
FD-36H 120V Toggle
FD-48H 120V Infinite
FD-48H 120V Toggle
FD-48L 120V Toggle
FD-60H 120V Toggle

Toasters

AT Express 120V
M-2000 208V
M-83 Toaster 120V
M-95-2 208V 55 Second
XTRM-2 208V

Warming

CFHS-21 120V
CW-1B QT 120V
CW-2Ai 120V
CW-2Ai 120V W/ Drain
CW-3A 120V
DW-1A 120V
PD-1A 120V
RCW-11 120V
RCW-11 120V Soup Pkg
RCW-7 120V
RCW-7 120V Soup Pkg
RW-1V 120V
RW-1V 120V Inset Pkg
RW-2V 120V
RW-2V 120V Inset Pkg
W-3Vi 120V
W-4-2 120V
W-43V 120V
W-4B Package 120V

Easy Design Resources

APW Wyott designs and specifications can be easily accessed on data systems including AutoQuotes and KCL CAD Library. You can also access our price list, manuals, and spec sheets on our website at www.apwwyott.com.

Enhanced Warranty Plan

APW Wyott has some of the most reliable products on the market. When issues arise at your operation, we have some of the fastest service response levels in the industry.

APW Wyott is a trusted source of food cooking, toasting, heating & holding, warming and merchandising solutions for customers in the retail, restaurant and institutional food service industries worldwide.

APW Wyott is a member of the Standex Food Service Equipment Group, along with other well-known cooking solutions brands, including Bakers Pride, BKI, Ultrafryer and Tri-Star. To learn more, visit www.apwwyott.com.



Champion Series Cookline

APW's renown Champion Cookline includes a full complement of food preparation and serving equipment designed to support commercial kitchens of any size. From countertop CharBroilers, Griddles, Hotplates and Fryers to state-of-the-art Induction cooking and heavy-duty steam tables, the Champion Cookline sets the benchmark for commercial kitchen equipment.

Champion Series Cookline Gas Radiant CharBroilers Heavy-Duty Steel Radiants for Optimal Heat Control

Gas Radiant CharBroilers feature heat dials that turn a full 180 degrees for ultimate control! Constructed of welded stainless and aluminized steel with heavy-duty stainless radiants. One of the highest BTU ratings in the industry, reaching temperatures of up to 825°F. Easy clean-up. Field convertible gas regulators. CE models include safety pilot. Cannot ship UPS. If shipping via air freight, dimensional weights apply. Backed by APW's Two Year Parts, Two Year Labor Warranty. FOB Standex Dock, freight class 70.



Radiant Advantages:

- 1) Provides a more "even heat" pattern across grill surface.
- 2) Easier to maintain and clean.
- 3) Less "flare-ups" in the broiling process.



Part Number	Model	Description	BTU	Radiants	Dimensions	Weight (lbs)	Price
22011180	GCB-18i	Convertible	60,000	3	15 5/8"H x 18"W x 26 7/8"D	96	\$1,628.00
22012180	GCB-18i (safety pilot)	Convertible	60,000	3	15 5/8"H x 18"W x 26 7/8"D	96	\$2,050.00
22011240	GCB-24i	Convertible	80,000	4	15 5/8"H x 24"W x 26 7/8"D	122	\$1,863.00
22012240	GCB-24i (safety pilot)	Convertible	80,000	4	15 5/8"H x 24"W x 26 7/8"D	122	\$2,175.00
22011360	GCB-36i	Convertible	120,000	6	15 5/8"H x 36"W x 26 7/8"D	174	\$2,641.00
22012360	GCB-36i (2 safety pilots)	Convertible	120,000	6	15 5/8"H x 36"W x 26 7/8"D	174	\$2,949.00
22011480	GCB-48i	Convertible	160,000	8	15 5/8"H x 48"W x 26 7/8"D	226	\$3,628.00
22012480	GCB-48i (2 safety pilots)	Convertible	160,000	8	15 5/8"H x 48"W x 26 7/8"D	226	\$4,227.00
Models for Export (safety pilot only)							
22013180	GCB-18i	Nat	60,000	3	15 5/8"H x 18"W x 26 7/8"D	96	\$2,050.00
22013182	GCB-18i	LP	60,000	3	15 5/8"H x 18"W x 26 7/8"D	96	\$2,050.00
22013240	GCB-24i	Nat	80,000	4	15 5/8"H x 24"W x 26 7/8"D	122	\$2,175.00
22013242	GCB-24i	LP	80,000	4	15 5/8"H x 24"W x 26 7/8"D	122	\$2,175.00
22013360	GCB-36i	Nat	120,000	6	15 5/8"H x 36"W x 26 7/8"D	174	\$2,949.00
22013362	GCB-36i	LP	120,000	6	15 5/8"H x 36"W x 26 7/8"D	174	\$2,949.00
22013480	GCB-48i	Nat	160,000	8	15 5/8"H x 48"W x 26 7/8"D	226	\$4,227.00
22013482	GCB-48i	LP	160,000	8	15 5/8"H x 48"W x 26 7/8"D	226	\$4,227.00

Champion Series Cookline CharRock Broilers CharRock Lava Stones for a Great Smoky Flavor

Gas CharRock Broilers feature heat dials that turn a full 180 degrees for ultimate control! All stainless and aluminized steel construction. Cast iron rock holder under grates. Each unit is shipped with a supply of lava rocks. One of the highest BTU ratings in the industry, reaching temperatures of up to 825°F. Field convertible gas regulators. CE models include safety pilot. Cannot ship UPS. If shipping air freight, dimensional weights apply. Backed by APW's Two Year Parts, Two Year Labor Warranty. FOB Standex Dock, freight class 70.

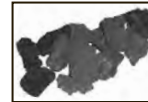

CharRock Advantages:

- 1) CharRocks build "visual excitement" with more flames and smoke.
- 2) Adds back flavor with sizzle of drippings from meats.



Part Number	Model	Description	BTU	Dimensions	Weight (lbs)	Price
22021180	GCRB-18i	Convertible	60,000	15 5/8"H x 18"W x 26 7/8"D	115	\$1,628.00
22022180	GCRB-18i (safety pilot)	Convertible	60,000	15 5/8"H x 18"W x 26 7/8"D	115	\$2,050.00
22021240	GCRB-24i	Convertible	80,000	15 5/8"H x 24"W x 26 7/8"D	148	\$1,863.00
22022240	GCRB-24i (safety pilot)	Convertible	80,000	15 5/8"H x 24"W x 26 7/8"D	148	\$2,175.00
22021360	GCRB-36i	Convertible	120,000	15 5/8"H x 36"W x 26 7/8"D	203	\$2,641.00
22022360	GCRB-36i (2 safety pilots)	Convertible	120,000	15 5/8"H x 36"W x 26 7/8"D	203	\$2,949.00
22021480	GCRB-48i	Convertible	160,000	15 5/8"H x 48"W x 26 7/8"D	270	\$3,628.00
22022480	GCRB-48i (2 safety pilots)	Convertible	160,000	15 5/8"H x 48"W x 26 7/8"D	270	\$4,227.00
Models for Export (safety pilot only)						
22023180	GCRB-18i	Nat	60,000	15 5/8"H x 18"W x 26 7/8"D	115	\$2,050.00
22023182	GCRB-18i	LP	60,000	15 5/8"H x 18"W x 26 7/8"D	115	\$2,050.00
22023240	GCRB-24i	Nat	80,000	15 5/8"H x 24"W x 26 7/8"D	148	\$2,175.00
22023242	GCRB-24i	LP	80,000	15 5/8"H x 24"W x 26 7/8"D	148	\$2,175.00
22023360	GCRB-36i	Nat	120,000	15 5/8"H x 36"W x 26 7/8"D	203	\$2,949.00
22023362	GCRB-36i	LP	120,000	15 5/8"H x 36"W x 26 7/8"D	203	\$2,949.00
22023480	GCRB-48i	Nat	160,000	15 5/8"H x 48"W x 26 7/8"D	270	\$4,227.00
22023482	GCRB-48i	LP	160,000	15 5/8"H x 48"W x 26 7/8"D	270	\$4,227.00

Thermostatic Gas Griddles

Thermostatic Gas Griddles feature heat dials that turn a full 210 degrees for ultimate control! Snap action controls with no electrical cord required. 1" griddle plate and a mechanical modulating valve/thermostat for maximum cooking control. 4" grease trough accepts full-sized spatulas. Welded stainless and aluminized steel, construction and 4" adjustable legs. Griddle plate is continuously welded to base. Field convertible gas regulators. CE models include safety pilot. Cannot ship UPS. If shipping via air freight, dimensional weights apply. Backed by APW's Two Year Parts, Two Year Labor Warranty. FOB Standex Dock, freight class 70.

Thermostatic Control Advantages:

- 1) Senses temperature on plate and regulates heat.
- 2) Ideal for cooking a variety of products in different temperatures zones.



Part Number	Model	Description	BTU	Dimensions	Weight (lbs)	Price
22031180	GGT-18i	Convertible	37,500	15 1/2"H x 18"W x 26 3/4"D	160	\$2,006.00
22032180	GGT-18i (safety pilot)	Convertible	37,500	15 1/2"H x 18"W x 26 3/4"D	160	\$2,397.00
22031240	GGT-24i	Convertible	50,000	15 1/2"H x 24"W x 26 3/4"D	223	\$2,950.00
22032240	GGT-24i (safety pilot)	Convertible	50,000	15 1/2"H x 24"W x 26 3/4"D	223	\$3,653.00
22031360	GGT-36i	Convertible	75,000	15 1/2"H x 36"W x 26 3/4"D	306	\$3,753.00
22032360	GGT-36i (2 safety pilots)	Convertible	75,000	15 1/2"H x 36"W x 26 3/4"D	306	\$4,473.00
22031480	GGT-48i	Convertible	100,000	15 1/2"H x 48"W x 26 3/4"D	350	\$4,830.00
22032480	GGT-48i (2 safety pilots)	Convertible	100,000	15 1/2"H x 48"W x 26 3/4"D	350	\$5,481.00
CE Models for Export (with ignitor and safety pilot)						
22035182	GGT-18i-CE	Nat	37,500	15 1/2"H x 18"W x 26 3/4"D	160	\$2,397.00
22035184	GGT-18i-CE	LP	37,500	15 1/2"H x 18"W x 26 3/4"D	160	\$2,397.00
22033244	GGT-24i-CE	Nat	50,000	15 1/2"H x 24"W x 26 3/4"D	223	\$3,653.00
22033246	GGT-24i-CE	LP	50,000	15 1/2"H x 24"W x 26 3/4"D	223	\$3,653.00
22033364	GGT-36i-CE	Nat	75,000	15 1/2"H x 36"W x 26 3/4"D	306	\$4,473.00
22033366	GGT-36i-CE	LP	75,000	15 1/2"H x 36"W x 26 3/4"D	306	\$4,473.00
22033484	GGT-48i-CE	Nat	100,000	15 1/2"H x 48"W x 26 3/4"D	350	\$5,481.00
22033486	GGT-48i-CE	LP	100,000	15 1/2"H x 48"W x 26 3/4"D	350	\$5,481.00

Manual Gas Griddles

Manual Gas Griddles feature heat dials that turn a full 180 degrees for ultimate control! 1" flat polished steel griddle plate, full 4" grease trough and shut-off valve, welded stainless and aluminized steel construction and 4" adjustable legs. Griddle plate is continuously welded. Field convertible gas regulators. CE models include safety pilot. Cannot ship UPS. If shipping via air freight, dimensional weights apply. Backed by APW's Two Year Parts, Two Year Labor Warranty. FOB Standex Dock, freight class 70.

Manual Control Advantages:

- 1) Great for High Heat
- 2) Highest BTUs drive fast temperature recoveries under heavy loads.
- 3) Needs "experienced cook" to manually control cooking zones.



Part Number	Model	Description	BTU	Dimensions	Weight (lbs)	Price
22041180	GGM-18i	Convertible	37,500	15 1/2"H x 18"W x 26 3/4"D	168	\$1,544.00
22042180	GGM-18i (safety pilot)	Convertible	37,500	15 1/2"H x 18"W x 26 3/4"D	168	\$1,867.00
22041240	GGM-24i	Convertible	50,000	15 1/2"H x 24"W x 26 3/4"D	214	\$1,835.00
22042240	GGM-24i (safety pilot)	Convertible	50,000	15 1/2"H x 24"W x 26 3/4"D	214	\$2,182.00
22041360	GGM-36i	Convertible	75,000	15 1/2"H x 36"W x 26 3/4"D	306	\$2,278.00
22042360	GGM-36i (2 safety pilots)	Convertible	75,000	15 1/2"H x 36"W x 26 3/4"D	306	\$2,694.00
22041480	GGM-48i	Convertible	100,000	15 1/2"H x 48"W x 26 3/4"D	350	\$3,085.00
22042480	GGM-48i (2 safety pilots)	Convertible	100,000	15 1/2"H x 48"W x 26 3/4"D	350	\$3,837.00
CE Models for Export (with ignitor and safety pilot only)						
22043180	GGM-18i-CE	Nat	37,500	15 1/2"H x 18"W x 26 3/4"D	168	\$1,867.00
22043182	GGM-18i-CE	LP	37,500	15 1/2"H x 18"W x 26 3/4"D	168	\$1,867.00
22045240	GGM-24i-CE	Nat	50,000	15 1/2"H x 24"W x 26 3/4"D	214	\$2,182.00
22045242	GGM-24i-CE	LP	50,000	15 1/2"H x 24"W x 26 3/4"D	214	\$2,182.00
22045360	GGM-36i-CE	Nat	75,000	15 1/2"H x 36"W x 26 3/4"D	306	\$2,694.00
22045362	GGM-36i-CE	LP	75,000	15 1/2"H x 36"W x 26 3/4"D	306	\$2,694.00
22045480	GGM-48i-CE	Nat	100,000	15 1/2"H x 48"W x 26 3/4"D	350	\$3,837.00
22043482	GGM-48i-CE	LP	100,000	15 1/2"H x 48"W x 26 3/4"D	350	\$3,837.00

Champion SERIES

Electric Griddles

Electric Griddles feature a 1" griddle plate, electronic snap action controls, welded stainless and aluminized steel construction and 4" adjustable legs. Griddle plate is continuously welded. Single phase is standard; field convertible to three phase. Available in 208/240V and 220V. Cannot ship UPS. If shipping via air freight, dimensional weights apply. Backed by APW's Two Year Parts, Two Year Labor Warranty. FOB Standex Dock, freight class 70.



Part Number	Model	Electric	Dimensions	Weight (lbs)	Price
22051240	EG-24i	208/240V, 6.75/9KW, 32.5/37.5 Amps	15 1/2"H x 24"W x 25"D	190	\$2,549.00
22058360	EG-36i	208/240V, 10KW/13.5, 48.7/53.6 Amps	15 1/2"H x 36"W x 25"D	270	\$3,085.00
22052480	EG-48i	208/240V, 13.5W/18, 65/75 Amps	15 1/2"H x 48"W x 25"D	383	\$4,440.00
CE Models for Export					
22053240	EG-24i-CE	400V, 8.2KW, 3 Ph	15 1/2"H x 24"W x 25"D	190	\$2,549.00
22053360	EG-36i-CE	400V, 12.4KW, 3 Ph	15 1/2"H x 36"W x 25"D	270	\$3,085.00
22053480	EG-48i-CE	400V, 16.5KW, 3 Ph	15 1/2"H x 48"W x 25"D	383	\$4,440.00

Flat Gas Hot Plates

36% More BTU Power Than Competitive Models

Heavy-Duty Stainless Steel welded construction with cast iron grates. Cast Iron burners generate 28,000 BTU/hr each. Stainless Steel drip pan. Available in 2, 4, and 6 burner versions, plus a 2 burner and 3 burner wide version. Field convertible gas regulators. Note: Cookline stands not available for 2i models. Cannot ship GHP-4i and GHP-6i UPS. If shipping via air freight, dimensional weights apply. Backed by APW's Two Year Parts, Two Year Labor Warranty. FOB Standex Dock, freight class 70.



Part Number	Model	Description	BTU	Dimensions	Weight (lbs)	Price
22561020	GHP-2i	Convertible	56,000	13 5/8"H x 12"W x 32"D	63	\$1,268.00
22571200	GHPW-2i	Convertible	56,000	14"H x 24"W x 19 1/2"D	68	\$1,240.00
22571300	GHPW-3i	Convertible	84,000	14"H x 36"W x 19 1/2"D	122	\$1,557.00
22561040	GHP-4i	Convertible	112,000	13 5/8"H x 24"W x 32"D	129	\$2,006.00
22561060	GHP-6i	Convertible	168,000	13 5/8"H x 36"W x 32"D	188	\$2,812.00
Models for Export (safety pilot only)						
22563020	GHP-2i	Nat	56,000	13 5/8"H x 12"W x 32"D	63	\$1,268.00
22563022	GHP-2i	LP	56,000	13 5/8"H x 12"W x 32"D	63	\$1,268.00
22563040	GHP-4i	Nat	112,000	13 5/8"H x 24"W x 32"D	129	\$2,006.00
22563042	GHP-4i	LP	112,000	13 5/8"H x 24"W x 32"D	129	\$2,006.00
22563060	GHP-6i	Nat	168,000	13 5/8"H x 36"W x 32"D	188	\$2,812.00
22563062	GHP-6i	LP	168,000	13 5/8"H x 36"W x 32"D	188	\$2,812.00

Champion Series Hot Plate Wok Ring Adaptor

Wok ring adaptor replaces Flat Gas Hotplate grate to accommodate standard woks. It can be ordered at the time of the original order or later, as a separate order. If shipping via air freight, dimensional weights apply. Backed by APW's One Year Warranty. FOB Standex Dock, freight class 100.



Part Number	Used With	Price
21815507	Wok Ring for GHPi Gas Hot Plates	\$289.00

Stepped Gas Hot Plates

Stepped version allows maximum control over cooking area. Heavy-duty stainless steel welded construction with cast iron grates. Cast Iron burners generate 28,000 BTU/hr each. Stainless Steel drip pan. Available in 2, 4, and 6 burner versions. Field convertible gas regulators. Note: Cookline stands not available for 2i models. Cannot ship UPS. If shipping via air freight, dimensional weights apply. Backed by APW's Two Year Parts, Two Year Labor Warranty. FOB Standex Dock, freight class 70.



Part Number	Model	Description	BTU	Dimensions	Weight (lbs)	Price
22571020	GHPS-2i	Convertible	56,000	16 3/4"H x 12"W x 24 3/4"L	68	\$1,701.00
22571040	GHPS-4i	Convertible	112,000	16 3/4"H x 24"W x 24 3/4"L	132	\$2,419.00
22571060	GHPS-6i	Convertible	168,000	16 3/4"H x 36"W x 24 3/4"L	188	\$3,414.00
CE Models for Export (safety pilot only)						
22573020	GHPS-2i	Nat	56,000	16 3/4"H x 12"W x 24 3/4"L	68	\$1,701.00
22573022	GHPS-2i	LP	56,000	16 3/4"H x 12"W x 24 3/4"L	68	\$1,701.00
22573040	GHPS-4i	Nat	112,000	16 3/4"H x 24"W x 24 3/4"L	132	\$2,419.00
22573042	GHPS-4i	LP	112,000	16 3/4"H x 24"W x 24 3/4"L	132	\$2,419.00
22573060	GHPS-6i	Nat	168,000	16 3/4"H x 36"W x 24 3/4"L	188	\$3,414.00
22573062	GHPS-6i	LP	168,000	16 3/4"H x 36"W x 24 3/4"L	188	\$3,414.00

Electric Hot Plates

Steel construction is an attractive presentation. Recessed controls prevent product or drippings from getting to controls. Indicating lights and 4" adjustable legs are standard. SEHPi Model features solid plate burners. Single phase is standard; convertible to 3 phase. Specify voltage. If shipping via air freight, dimensional weights apply. Backed by APW's Two Year Parts, Two Year Labor Warranty. FOB Standex Dock, freight class 100.



Part Number	Model	Electric	Dimensions	Weight (lbs)	Price
22081000	EHPI	208V, 4200W, 20.2 Amps	14"H x 12"W x 24 3/4"D	39	\$1,211.00
22082000	EHPI	240V, 4200W, 17.5 Amps	14"H x 12"W x 24 3/4"D	39	\$1,211.00
22088010	SEHPI	208V, 4000W, 23.1 Amps	14"H x 12"W x 24 3/4"D	45	\$1,311.00
22082010	SEHPI	240V, 4000W, 16.7 Amps	14"H x 12"W x 24 3/4"D	45	\$1,311.00

Electric Portable Hot Plates

Electric Hot Plates are portable, yet sturdy! Choose from a single or double burner hot plate. Double hot plate has 1250W and 550W burner separation. 66" Cord and plug included with each unit. If shipping via air freight, dimensional weights apply. Backed by APW's One Year Warranty. FOB Standex Dock, freight class 100.



Part Number	Model	Description	Electric	Dimensions	Weight (lbs)	Price
63401	CP-1A	Single	120V, 1250W, 10.4 Amps	5"H x 10 7/8"W x 10 7/8"D	10	\$513.00
63601	CP-2A	Double	120V, 1800W, 15.0 Amps	5"H x 24 3/4"W x 10 7/8"D	17	\$881.00
63301	CHP-1A	Single	120V, 1650W, 13.8 Amps	7 1/8"H x 12 3/4"W x 12 3/4"D	14	\$681.00

Induction Cooking Commercial Hot Plates

For use with Ferrous Stainless Steel, Iron or Cast Iron induction-ready cookware, these back of the house countertop induction hot plates feature rotary power control with nine power settings and four pre-set push buttons. Available in single, dual or quad burner models, they offer 3.5KW, 7KW and 14KW of power respectively. 4" adjustable heavy duty legs are standard. Backed by APW's One Year Warranty. FOB Standex Dock, freight class 70.



Part Number	Model	Description	Electric	Dimensions	Weight (lbs)	Price
25001021	IHP-1	Single	208/240V, Single Ph, 2629/3500W, 13/15 Amps	12 7/8"H x 17"W x 24 1/2"D	50	\$3,099.00
25001022	IHP-2	Double	208/240V, Three Ph, 5258/7000W, 22/25 Amps	12 7/8"H x 17"W x 32 1/4"D	115	\$5,200.00
25001024	IHP-4	Quad	208/240V, Three Ph, 10516/14000W, 44/50 Amps	12 7/8"H x 32 1/2"W x 32 1/4"D	260	\$9,403.00

Induction Cooking Sauté Hot Plate

For use with Ferrous Stainless Steel, Iron or Cast Iron induction-ready cookware, these induction cooking sauté hot plates feature rotary power control with nine power settings. Available in 120V, it offers 1800W of power. 1" rubberized feet are standard. Backed by APW's One Year Warranty. FOB Standex Dock, freight class 70.



Part Number	Model	Description	Electric	Dimensions	Weight (lbs)	Price
25001004	ICT-18A	Single	120V, 1800W, 50/60Hz 15.2 Amps	4 3/8"H x 13"W x 16 5/8"D	18	\$1,313.00

Induction Cooking Wok Hot Plate

For use with Ferrous Stainless Steel, Iron or Cast Iron induction-ready cookware, these induction cooking wok hot plates feature rotary power control with nineteen power settings and 20 hold temperatures. Available in 208V, they offer 3000W of power. 4" adjustable legs are standard. Backed by APW's One Year Warranty. FOB Standex Dock, freight class 70.



Part Number	Model	Description	Electric	Dimensions	Weight (lbs)	Price
25001030	IWK-1	Single	208/240V, Single Ph, 3200/3500W, 50/60Hz 15 Amps	12 7/8"H x 17"W x 24 1/2"D	50	\$3,257.00

Induction Cooking Buffet Warming Plate

For use with Ferrous Stainless Steel, Iron or Cast Iron induction-ready cookware. This recessed buffet induction warming plate features rotary power control with three high settings and three low settings. Available in 120V model, it offers 480W of power. Flush mount control panels with digital readouts are standard. Backed by APW's One Year Warranty. FOB Standex Dock, freight class 100.



Part Number	Model	Description	Electric	Dimensions	Weight (lbs)	Price
25001010	IBB-05F	Single	120V, 480W, 50/60Hz, 4 Amps	4"H x 12 5/8"W x 12 5/8"D	10	\$966.00

Champion SERIES

Champion Series CheeseMelters

CheeseMelters provide the ultimate finishing capabilities. These countertop models include fan-cooled control compartments and quartz elements. CheeseMelters have a four shelf height "microswitch" that is activated by placing a plate on the shelf. All units are single phase. 48 inch versions cannot ship UPS. If shipping via air freight, dimensional weights apply. Backed by APW's One Year Warranty. FOB Standex Dock, freight class 70. (Also suitable for operation on 230V/50HZ)



Part Number	Model	Electric	Dimensions	Weight (lbs)	Price
Countertop					
33020800	CMC-24	208V, 2.4KW, 11.5 Amps	19"H x 27"W x 17"D	76	\$3,539.00
33020900	CMC-24	240V, 2.4KW, 10 Amps	19"H x 27"W x 17"D	76	\$3,539.00
33021500	CMC-36	208V, 3.6KW, 17.3 Amps	19"H x 36 1/2"W x 17"D	92	\$3,909.00
33021600	CMC-36	240V, 3.6KW, 15 Amps	19"H x 36 1/2"W x 17"D	92	\$3,909.00
33022100	CMC-48	208V, 4.2KW, 20.2 Amps	19"H x 50"W x 17"D	130	\$5,158.00
33025700	CMC-48	240V, 4.2KW, 17.5 Amps	19"H x 50"W x 17"D	130	\$5,158.00
Wall Mount					
33021200	CMW-24	208V, 2.4KW, 11.5 Amps	15"H x 27"W x 17"D	78	\$4,134.00
33021300	CMW-24	240V, 2.4KW, 10 Amps	15"H x 27"W x 17"D	78	\$4,134.00
33021900	CMW-36	208V, 3.6KW, 17.3 Amps	15"H x 36 1/2"W x 17"D	92	\$4,567.00
33022000	CMW-36	240V, 3.6KW, 15 Amps	15"H x 36 1/2"W x 17"D	92	\$4,567.00
33022400	CMW-48	208V, 4.2KW, 20.2 Amps	15"H x 50"W x 17"D	130	\$6,024.00
33022500	CMW-48	240V, 4.2KW, 17.5 Amps	15"H x 50"W x 17"D	130	\$6,024.00
Pass Through					
33021000	CMP-24	208V, 2.4KW, 11.5 Amps	19"H x 27"W x 15 1/8"D	78	\$3,941.00
33021100	CMP-24	240V, 2.4KW, 10 Amps	19"H x 27"W x 15 1/8"D	78	\$3,941.00
33021700	CMP-36	208V, 3.6KW, 17.3 Amps	19"H x 36 1/2"W x 15 1/8"D	92	\$4,436.00
33021800	CMP-36	240V, 3.6KW, 15 Amps	19"H x 36 1/2"W x 15 1/8"D	92	\$4,436.00
33022200	CMP-48	208V, 4.2KW, 20.2 Amps	19"H x 49 1/2"W x 15 1/8"D	130	\$5,913.00
33022300	CMP-48	240V, 4.2KW, 17.5 Amps	19"H x 49 1/2"W x 15 1/8"D	130	\$5,913.00
Internal Dimensions					
	24 inch Model	21 1/4"W x 9 13/16"H x 14 1/2"D			
	36 inch Model	30 3/4"W x 9 13/16"H x 14 1/2"D			
	48 inch Model	42 1/4"W x 9 13/16"H x 14 1/2"D			
Internal Dimensions					
4939100	Set of four legs				\$157.00

Champion Series Gas Countertop Fryers

Countertop Fryers available in 2 sizes for different capacity; APW-F15C has 15 pound capacity and APW-F25C has 25 pound capacity. All fryers are capable of high capacity and high production cooking. High performance burners allows instant recovery at extreme peak periods of production. Specify type of gas and elevation if over 2,000 ft. If shipping via air freight, dimensional weights apply. Backed by APW's One Year Warranty. FOB Standex Dock, freight class 85.



Part Number	Model	Description	BTU	Baskets	Dimensions	Weight (lbs)	Price
301900	APW-F15C	Nat	40,000	(2) Half Size	20 3/4"H x 12"W x 29"D	75	\$1,841.00
301902	APW-F15C	LP	40,000	(2) Half Size	20 3/4"H x 12"W x 29"D	75	\$1,841.00
302000	APW-F25C	Nat	60,000	(2) Full Size	20 3/4"H X 15 1/2"W x 29"D	100	\$2,304.00
302002	APW-F25C	LP	60,000	(2) Full Size	20 3/4"H X 15 1/2"W x 29"D	100	\$2,304.00
Accessories		Description					
300412	Basket	11" x 4.5" x 5" for 15C Fryer					\$83.00
300510	Basket	12" x 6" x 5" for 25C Fryer					\$83.00
390156	Cover Vessel	15C					\$71.00
390147	Cover Vessel	25C					\$77.00
390151	Mesh Fryer Filter	15C					\$32.00
390152	Mesh Fryer Filter	25C					\$35.00

Champion SERIES

Champion Series Electric Countertop Fryers

Electric Fryers feature all stainless steel construction, includes one-piece, lift-out tank. 15# Fryers come with two half-size baskets; 30# Fryers come with two full-size baskets. The EF-30iNT has twin 15# tanks. Thermostatic control is located below the frying zone allowing for safe operation and long life. Only the EF-30i, EF-30iNT and EF-15iN have top controls. Includes 4" adjustable legs. Model EF-30i not available to ship UPS. EF-30iNT ONLY is not CUL approved. If shipping via air freight, dimensional weights apply. Backed by APW's Two Year Warranty. FOB Standex Dock, freight class 85.



Part Number	Model	Electric	Baskets	Dimensions	Weight (lbs)	Price
22091150	EF-15iN	208/240V, 5.7/4.28W, 23.8/ 20.6 Amps	(2) Half Size	16 3/8"H x 12"W x 24"D	36	\$1,999.00
22091300	EF-30i	208V, 12KW, 58 Amps	(2) Full Size	17"H X 24"W x 24 1/2"D	92	\$3,438.00
22094300	EF-30i	240V, 12KW, 50.0 Amps	(2) Full Size	17"H X 24"W x 24 1/2"D	92	\$3,438.00
22090300	EF-30iNT	208/240V, 11.4/ 8.56 KW, 47.7/ 41.2 Amps	(2) Full Size	16 3/8"H x 24"W x 24"D	66	\$3,520.00
Export Models						
22093150	EF-15iN	230V, 3.6KW, 16.3 Amps		16 3/8"H x 12"W x 24"D	36	\$1,999.00
22092300	EF-30i	220V, 10.1KW, 45.8 Amps		17"H X 24"W x 24 1/2"D	92	\$3,438.00
22093300	EF-30iNT	230V, 7.2KW, 32.7 Amps		16 3/8"H x 24"W x 24"D	66	\$3,520.00
Options:		Used With	Description			
3101230		EF-15iN or EF-30iNT	Basket 1/2 Size			\$184.00
3101232		EF-15iN or EF-30iNT	Basket Full Size			\$192.00
3101225		EF-30i	Basket Left Hand			\$267.00
3101226		EF-30i	Basket Right Hand			\$267.00

Champion Series Countertop Deck Ovens

Double the cooking capacity in a compact space. Oven compartment has two Cordierite Hearth Decks 16 3/8" x 16 7/8" which are removable for easy cleaning. Unit is insulated on all sides with stainless steel top, sides and door liner. CDO-18's thermostat range is 300 °F - 680 °F and includes a 15 minute timer and two ceramic decks. CDO-18B includes a 60-minute timer and one ceramic deck with a thermostat range of 300°F – 550°F. Available in 120V, 208V or 240V. Backed by APW's One Year Warranty. FOB Standex Dock, freight class 110.



Part Number	Model	Electric	Dimensions	Weight (lbs)	Price
21716800	CDO-18	120V, 1500W, 15 Amps	23"H x 25"W x 17"D	125	\$3,373.00
21717700	CDO-18	208/240V, 1500W, 15 Amps	23"H x 25"W x 17"D	125	\$3,373.00
21779300	CDO-18B	120V, 1600W, 7.7 Amps	23"H x 25"W x 17"D	125	\$3,094.00
21779200	CDO-18B	208/240V, 2140W, 9 Amps	23"H x 25"W x 17"D	125	\$3,184.00
Export Models					
21717600	CDO-18	230V, 1830W, 8.3 Amps	23"H x 25"W x 17"D	125	\$3,373.00

Champion Series Energy Efficient Tortilla Grills

Energy Efficient Tortilla Grill comes with adjustable snap action thermostat. Heats from 100°-425° F. Complete with cord and plug. 20" X 23 1/2" x 5/16" thick polished aluminum griddle surface. If shipping via air freight, dimensional weights apply. Backed by APW's One Year Warranty. FOB Standex Dock, freight class 85.



Part Number	Model	Electric	Dimensions	Weight (lbs)	Price
21806200	TG-2025*	120V, 1200W, 10 Amps	7 3/8"H x 24 5/8"W x 21 5/8"D	55	\$3,016.00
21806208	TG-2025	208V, 1200W, 5.8 Amps	7 3/8"H x 24 5/8"W x 21 5/8"D	55	\$3,016.00
21806240	TG-2025	240V, 1600W, 6.7 Amps	7 3/8"H x 24 5/8"W x 21 5/8"D	55	\$3,016.00

*Volume Orders Only

Champion Series Cookline Stands

Medium-duty cooking stands constructed of stainless steel top shelf, aluminized bottom shelf and galvanized legs. Each stand is equipped with 4" legs or 5" casters. L after the model number specifies legs and C specifies casters. If shipping via air freight, dimensional weights apply. Backed by APW's One Year Warranty. FOB Standex Dock, freight class 70.



Part Number	Model	Dimensions	Weight (lbs)	Price
221800	SSS-18L	24 1/2"H x 18"W x 24"D w/Legs	33	\$403.00
221801	SSS-18C	24 1/2"H x 18"W x 24"D w/Casters	45	\$529.00
222400	SSS-24L	24 1/2"H x 24"W x 24"D w/Legs	42	\$458.00
222401	SSS-24C	24 1/2"H x 24"W x 24"D w/Casters	49	\$578.00
223600	SSS-36L	24 1/2"H x 36"W x 24"D w/Legs	51	\$572.00
223601	SSS-36C	24 1/2"H x 36"W x 24"D w/Casters	59	\$689.00
224800	SSS-48L	24 1/2"H x 48"W x 24"D w/Legs	63	\$628.00
224801	SSS-48C	24 1/2"H x 48"W x 24"D w/Casters	70	\$745.00
226000	SSS-60L	24 1/2"H x 60"W x 24"D w/Legs	74	\$725.00
226001	SSS-60C	24 1/2"H x 60"W x 24"D w/Casters	80	\$842.00
227200	SSS-72L	24 1/2"H x 72"W x 24"D w/Legs	86	\$849.00
227201	SSS-72C	24 1/2"H x 72"W x 24"D w/Casters	92	\$964.00

Champion Series Cookline Accessories

The following accessories are available to our customers to allow them the maximum capabilities to configure their Champion Cookline to their particular operation. All cooking accessories can be ordered at the time of the original order or later, as a separate order. If shipping via air freight, dimensional weights apply. Backed by APW's One Year Warranty. FOB Standex Dock, freight class 100.



Part Number	Used With	Price
21813400	Steak Char version Top Grate (5.8" wide) for CharBroilers	\$74.00
3102202	Fish version (5.78" wide) Top Grate CharBroiles	\$396.00
21813095	Top Griddle Plate (11.8" wide) for CharBroilers (Converts a section of the CharGrill to a griddle surface)	\$89.00
21813700	Top Grate Gas Hot Plate (1)	\$91.00
21813500	Bottom Rock Grate CharBroiler (4.88" wide)	\$67.00
3100002	CharRocks Bag (8 pounds) - suitable for 36" CharBroiler	\$39.00
21813600	Cookline 4 inch Heavy-Duty Legs (Kit contains 4)	\$93.00
21815507	Wok Ring for GHPI Gas Hot Plates	\$289.00

Hot Well - Exposed Steam Tables

Individual Infinite Switch Heat Controls with Exposed Element as Standard

Unit body constructed of heavy-duty stainless steel with die stamped top. Each compartment insulated with mineral wool insulation. Unit standard with stainless steel liner. Individual infinite switch heat controls with 500 watt element as standard. Unit equipped with 1/2" poly cutting board mounted on stainless steel shelf supported by stainless steel brackets. Units available with either stainless steel legs and undershelf or coated legs and undershelf. Cord and plug supplied with standard units. Backed by APW's One Year Warranty. FOB Standex Dock, freight class 100.



Part Number	Model	Description	Electric	Dimensions	Weight (lbs)	Price
Stationary with Coated Steel Legs and Undershelf						
32010400	ST-120-2	2 Well	120V, 1000W, 8.33 Amps	35"H x 30 1/2"W x 22 1/2"D	97	\$1,755.00
32011118	ST-208-2	2 Well	208V, 1P, 1500W, 7.21 Amps	35"H x 30 1/2"W x 22 1/2"D	97	\$1,755.00
32011119	ST-240-2	2 Well	240V, 1P, 1500W, 6.25 Amps	35"H x 30 1/2"W x 22 1/2"D	97	\$1,755.00
32010410	ST-120-3	3 Well	120V, 1500W, 12.5 Amps	35"H x 44 1/2"W x 22 1/2"D	125	\$2,017.00
32010610	ST-208-3	3 Well	208V, 1P, 2250W, 10.82 Amps	35"H x 44 1/2"W x 22 1/2"D	125	\$2,017.00
32011120	ST-240-3	3 Well	240V, 1P, 2250W, 9.38 Amps	35"H x 44 1/2"W x 22 1/2"D	125	\$2,017.00
32010420	ST-120-4	4 Well	120V, 2000W, 16.67 Amps	35"H x 58 1/2"W x 22 1/2"D	158	\$2,739.00
32010370	ST-208-4	4 Well	208V, 1P, 3000W, 14.42 Amps	35"H x 58 1/2"W x 22 1/2"D	158	\$2,739.00
32010630	ST-240-4	4 Well	240V, 1P, 3000W, 12.5 Amps	35"H x 58 1/2"W x 22 1/2"D	158	\$2,739.00
32010430	ST-120-5	5 Well	120V, 2500W, 20.83 Amps	35"H x 79"W x 22 1/2"D	193	\$3,666.00
32010760	ST-208-5	5 Well	208V, 1P, 3750W, 18.03 Amps	35"H x 79"W x 22 1/2"D	193	\$3,666.00
32011121	ST-240-5	5 Well	240V, 1P, 3750W, 15.63 Amps	35"H x 79"W x 22 1/2"D	193	\$3,666.00
Stationary with Stainless Steel Legs and Undershelf						
32010000	ST-120-2S	2 Well	120V, 1000W, 8.33 Amps	35"H x 30 1/2"W x 22 1/2"D	97	\$1,944.00
32011101	ST-208-2S	2 Well	208V, 1P, 1500W, 7.21 Amps	35"H x 30 1/2"W x 22 1/2"D	97	\$1,944.00
32011102	ST-240-2S	2 Well	240V, 1P, 1500W, 6.25 Amps	35"H x 30 1/2"W x 22 1/2"D	97	\$1,944.00
32010010	ST-120-3S	3 Well	120V, 1500W, 12.5 Amps	35"H x 44 1/2"W x 22 1/2"D	125	\$2,146.00
32010360	ST-208-3S	3 Well	208V, 1P, 2250W, 10.82 Amps	35"H x 44 1/2"W x 22 1/2"D	125	\$2,146.00
32011103	ST-240-3S	3 Well	240V, 1P, 2250W, 9.38 Amps	35"H x 44 1/2"W x 22 1/2"D	125	\$2,146.00
32010020	ST-120-4S	4 Well	120V, 2000W, 16.67 Amps	35"H x 58 1/2"W x 22 1/2"D	158	\$2,851.00
32010380	ST-208-4S	4 Well	208V, 1P, 3000W, 14.42 Amps	35"H x 58 1/2"W x 22 1/2"D	158	\$2,851.00
32010620	ST-240-4S	4 Well	240V, 1P, 3000W, 12.5 Amps	35"H x 58 1/2"W x 22 1/2"D	158	\$2,851.00
32010030	ST-120-5S	5 Well	120V, 2500W, 20.83 Amps	35"H x 79"W x 22 1/2"D	193	\$3,649.00
32010770	ST-208-5S	5 Well	208V, 1P, 3750W, 18.03 Amps	35"H x 79"W x 22 1/2"D	193	\$3,649.00
32010780	ST-240-5S	5 Well	240V, 1P, 3750W, 15.63 Amps	35"H x 79"W x 22 1/2"D	193	\$3,649.00
* 3 Phase also available – consult factory for information						
Portable with Coated Steel Legs and Undershelf						
32010440	PST-120-2	2 Well	120V, 1000W, 8.33 Amps	35"H x 30 1/2"W x 22 1/2"D	101	\$2,162.00
32011122	PST-208-2	2 Well	208V, 1P, 1500W, 7.21 Amps	35"H x 30 1/2"W x 22 1/2"D	101	\$2,162.00
32011123	PST-240-2	2 Well	240V, 1P, 1500W, 6.25 Amps	35"H x 30 1/2"W x 22 1/2"D	101	\$2,162.00
32010450	PST-120-3	3 Well	120V, 1500W, 12.5 Amps	35"H x 44 1/2"W x 22 1/2"D	129	\$2,431.00
32011124	PST-208-3	3 Well	208V, 1P, 2250W, 10.82 Amps	35"H x 44 1/2"W x 22 1/2"D	129	\$2,431.00
32011125	PST-240-3	3 Well	240V, 1P, 2250W, 9.38 Amps	35"H x 44 1/2"W x 22 1/2"D	129	\$2,431.00
32010460	PST-120-4	4 Well	120V, 2000W, 16.67 Amps	35"H x 58 1/2"W x 22 1/2"D	169	\$3,336.00
32011126	PST-208-4	4 Well	208V, 1P, 3000W, 14.42 Amps	35"H x 58 1/2"W x 22 1/2"D	169	\$3,336.00
32011127	PST-240-4	4 Well	240V, 1P, 3000W, 12.5 Amps	35"H x 58 1/2"W x 22 1/2"D	169	\$3,336.00
32010470	PST-120-5	5 Well	120V, 2500W, 20.83 Amps	35"H x 72 1/2"W x 22 1/2"D	199	\$4,060.00
32011128	PST-208-5	5 Well	208V, 1P, 3750W, 18.03 Amps	35"H x 72 1/2"W x 22 1/2"D	199	\$4,060.00
32011129	PST-240-5	5 Well	240V, 1P, 3750W, 15.63 Amps	35"H x 72 1/2"W x 22 1/2"D	199	\$4,060.00
Portable with Stainless Steel Legs and Undershelf						
32010040	PST-120-2S	2 Well	120V, 1000W, 8.33 Amps	35"H x 30 1/2"W x 22 1/2"D	101	\$2,358.00
32011104	PST-208-2S	2 Well	208V, 1P, 1500W, 7.21 Amps	35"H x 30 1/2"W x 22 1/2"D	101	\$2,358.00
32011105	PST-240-2S	2 Well	240V, 1P, 1500W, 6.25 Amps	35"H x 30 1/2"W x 22 1/2"D	101	\$2,358.00
32010050	PST-120-3S	3 Well	120V, 1500W, 12.5 Amps	35"H x 44 1/2"W x 22 1/2"D	129	\$2,549.00
32011106	PST-208-3S	3 Well	208V, 1P, 2250W, 10.82 Amps	35"H x 44 1/2"W x 22 1/2"D	129	\$2,549.00
32011107	PST-240-3S	3 Well	240V, 1P, 2250W, 9.38 Amps	35"H x 44 1/2"W x 22 1/2"D	129	\$2,549.00
32010060	PST-120-4S	4 Well	120V, 2000W, 16.67 Amps	35"H x 58 1/2"W x 22 1/2"D	169	\$3,505.00
32010390	PST-208-4S	4 Well	208V, 1P, 3000W, 14.42 Amps	35"H x 58 1/2"W x 22 1/2"D	169	\$3,505.00
32011108	PST-240-4S	4 Well	240V, 1P, 3000W, 12.5 Amps	35"H x 58 1/2"W x 22 1/2"D	169	\$3,505.00
32010070	PST-120-5S	5 Well	120V, 2500W, 20.83 Amps	35"H x 72 1/2"W x 22 1/2"D	199	\$4,379.00
32011109	PST-208-5S	5 Well	208V, 1P, 3750W, 18.03 Amps	35"H x 72 1/2"W x 22 1/2"D	199	\$4,379.00
32011110	PST-240-5S	5 Well	240V, 1P, 3750W, 15.63 Amps	35"H x 72 1/2"W x 22 1/2"D	199	\$4,379.00

Hot Well - Sealed Steam Tables

Individual Infinite Switch Heat Controls with Sealed Well as Standard

Unit body constructed of heavy-duty stainless steel with deep drawn stainless steel wells. Fully welded drains in wells. Individual infinite switch heat controls with 750 watt element as standard. Unit equipped with 1/2" poly cutting board mounted on stainless steel shelf supported by stainless steel brackets. Unit supplied standard with copper manifold and gate valve. Units available with either stainless steel legs and undershelf or coated legs and undershelf. Cord and plug supplied with standard unit. Backed by APW's One Year Warranty. FOB Standex Dock, freight class 100.



Part Number	Model	Description	Electric	Dimensions	Weight (lbs)	Price
Stationary with Coated Steel Legs and Undershelf						
32010080	SST-120-2	2 Well	120V, 1500W, 12.5 Amps	35"H x 31 1/2"W x 22 1/2"D	101	\$2,038.00
32011130	SST-208-2	2 Well	208V, 1500W, 7.21 Amps	35"H x 31 1/2"W x 22 1/2"D	101	\$2,038.00
32011131	SST-240-2	2 Well	240V, 1500W, 6.25 Amps	35"H x 31 1/2"W x 22 1/2"D	101	\$2,038.00
32010090	SST-120-3	3 Well	120V, 2250W, 18.75 Amps	35"H x 45"W x 22 1/2"D	129	\$2,472.00
32010810	SST-208-3	3 Well	208V, 2250W, 10.82 Amps	35"H x 45"W x 22 1/2"D	129	\$2,472.00
32010820	SST-240-3	3 Well	240V, 2250W, 9.38 Amps	35"H x 45"W x 22 1/2"D	129	\$2,472.00
32010890	SST-120-4	4 Well	120V, 3000W, 25 Amps	35"H x 60"W x 22 1/2"D	162	\$3,487.00
32010900	SST-208-4	4 Well	208V, 3000W, 14.42 Amps	35"H x 60"W x 22 1/2"D	162	\$3,487.00
32010910	SST-240-4	4 Well	240V, 3000W, 12.5 Amps	35"H x 60"W x 22 1/2"D	162	\$3,487.00
32010350	SST-120-5	5 Well	120V, 3750W, 31.25 Amps	35"H x 74 1/2"W x 22 1/2"D	199	\$4,641.00
32010950	SST-208-5	5 Well	208V, 3750W, 18.03 Amps	35"H x 74 1/2"W x 22 1/2"D	199	\$4,641.00
32011132	SST-240-5	5 Well	240V, 3750W, 15.63 Amps	35"H x 74 1/2"W x 22 1/2"D	199	\$4,641.00
Stationary with Stainless Steel Legs and Undershelf						
32010790	SST-120-2S	2 Well	120V, 1500W, 12.5 Amps	35"H x 31 1/2"W x 22 1/2"D	101	\$2,101.00
32011111	SST-208-2S	2 Well	208V, 1500W, 7.21 Amps	35"H x 31 1/2"W x 22 1/2"D	101	\$2,101.00
32011112	SST-240-2S	2 Well	240V, 1500W, 6.25 Amps	35"H x 31 1/2"W x 22 1/2"D	101	\$2,101.00
32010830	SST-120-3S	3 Well	120V, 2250W, 18.75 Amps	35"H x 45"W x 22 1/2"D	129	\$2,534.00
32010840	SST-208-3S	3 Well	208V, 2250W, 10.82 Amps	35"H x 45"W x 22 1/2"D	129	\$2,534.00
32010850	SST-240-3S	3 Well	240V, 2250W, 9.38 Amps	35"H x 45"W x 22 1/2"D	129	\$2,534.00
32010920	SST-120-4S	4 Well	120V, 3000W, 25 Amps	35"H x 60"W x 22 1/2"D	162	\$3,553.00
32010930	SST-208-4S	4 Well	208V, 3000W, 14.42 Amps	35"H x 60"W x 22 1/2"D	162	\$3,553.00
32010940	SST-240-4S	4 Well	240V, 3000W, 12.5 Amps	35"H x 60"W x 22 1/2"D	162	\$3,553.00
32010340	SST-120-5S	5 Well	120V, 3750W, 31.25 Amps	35"H x 74 1/2"W x 22 1/2"D	199	\$4,706.00
32010960	SST-208-5S	5 Well	208V, 3750W, 18.03 Amps	35"H x 74 1/2"W x 22 1/2"D	199	\$4,706.00
32010970	SST-240-5S	5 Well	240V, 3750W, 15.63 Amps	35"H x 74 1/2"W x 22 1/2"D	199	\$4,706.00
* 120V/1200Watt 208V/1200Watt and 240V/1600W also available						
*3 Phase also available – consult factory for information						
Portable with Coated Steel Legs and Undershelf						
32010500	PSST-120-2	2 Well	120V, 1500W, 12.5 Amps	35"H x 31 1/2"W x 22 1/2"D	101	\$2,515.00
32011133	PSST-208-2	2 Well	208V, 1500W, 7.21 Amps	35"H x 31 1/2"W x 22 1/2"D	101	\$2,515.00
32011134	PSST-240-2	2 Well	240V, 1500W, 6.25 Amps	35"H x 31 1/2"W x 22 1/2"D	101	\$2,515.00
32010210	PSST-120-3	3 Well	120V, 2250W, 18.75 Amps	35"H x 45"W x 22 1/2"D	129	\$2,909.00
Contact Customer Service	PSST-208-3	3 Well	208V, 2250W, 10.82 Amps	35"H x 45"W x 22 1/2"D	129	\$2,909.00
32011135	PSST-240-3	3 Well	240V, 2250W, 9.38 Amps	35"H x 45"W x 22 1/2"D	129	\$2,909.00
32010490	PSST-120-4	4 Well	120V, 3000W, 25 Amps	35"H x 60"W x 22 1/2"D	162	\$4,171.00
32011136	PSST-208-4	4 Well	208V, 3000W, 14.42 Amps	35"H x 60"W x 22 1/2"D	162	\$4,171.00
32011137	PSST-240-4	4 Well	240V, 3000W, 12.5 Amps	35"H x 60"W x 22 1/2"D	162	\$4,171.00
32010520	PSST-120-5	5 Well	120V, 3750W, 31.25 Amps	35"H x 74 1/2"W x 22 1/2"D	199	\$5,427.00
32011139	PSST-208-5	5 Well	208V, 3750W, 18.03 Amps	35"H x 74 1/2"W x 22 1/2"D	199	\$5,427.00
32011141	PSST-240-5	5 Well	240V, 3750W, 15.63 Amps	35"H x 74 1/2"W x 22 1/2"D	199	\$5,427.00
Portable with Stainless Steel Legs and Undershelf						
32010800	PSST-120-2S	2 Well	120V, 1500W, 12.5 Amps	35"H x 31 1/2"W x 22 1/2"D	101	\$2,538.00
32011113	PSST-208-2S	2 Well	208V, 1500W, 7.21 Amps	35"H x 31 1/2"W x 22 1/2"D	101	\$2,538.00
32011114	PSST-240-2S	2 Well	240V, 1500W, 6.25 Amps	35"H x 31 1/2"W x 22 1/2"D	101	\$2,538.00
32010870	PSST-120-3S	3 Well	120V, 2250W, 18.75 Amps	35"H x 45"W x 22 1/2"D	129	\$2,951.00
32010880	PSST-208-3S	3 Well	208V, 2250W, 10.82 Amps	35"H x 45"W x 22 1/2"D	129	\$2,951.00
32011115	PSST-240-3S	3 Well	240V, 2250W, 9.38 Amps	35"H x 45"W x 22 1/2"D	129	\$2,951.00
32010480	PSST-120-4S	4 Well	120V, 3000W, 25 Amps	35"H x 60"W x 22 1/2"D	162	\$4,278.00
32011116	PSST-208-4S	4 Well	208V, 3000W, 14.42 Amps	35"H x 60"W x 22 1/2"D	162	\$4,278.00
32011117	PSST-240-4S	4 Well	240V, 3000W, 12.5 Amps	35"H x 60"W x 22 1/2"D	162	\$4,278.00
32010510	PSST-120-5S	5 Well	120V, 3750W, 31.25 Amps	35"H x 74 1/2"W x 22 1/2"D	199	\$5,504.00
32011138	PSST-208-5S	5 Well	208V, 3750W, 18.03 Amps	35"H x 74 1/2"W x 22 1/2"D	199	\$5,504.00
32011140	PSST-240-5S	5 Well	240V, 3750W, 15.63 Amps	35"H x 74 1/2"W x 22 1/2"D	199	\$5,504.00

Champion SERIES

Hot Well - Gas Steam Tables

All Hot Well Gas Steam Tables and Wet Bath Steam Tables are constructed of heavy gauge stainless steel with die stamped top. Stainless steel liner is standard. Unit equipped with 1/2" thick Poly cutting board mounted on stainless steel shelf supported by stainless steel brackets. Recessed controls for improved protection and safety. Backed by APW's One Year Warranty. FOB Standex Dock, freight class 100.



Part Number	Model	Description	BTU	Dimensions	Weight (lbs)	Price
Hot Well with Galvanized Undershef and Legs						
32012050	GST-2	2 well, Nat	7,000	35"H x 30 5/8"W x 22 1/2"D	97	\$1,665.00
32012052	GST-2	2 well, LP	7,000	35"H x 30 5/8"W x 22 1/2"D	97	\$1,665.00
32012060	GST-3	3 well, Nat	10,500	35"H x 44 5/8"W x 22 1/2"D	125	\$2,235.00
32012062	GST-3	3 well, LP	10,500	35"H x 44 5/8"W x 22 1/2"D	125	\$2,235.00
32012070	GST-4	4 well, Nat	14,000	35"H x 58 5/8"W x 22 1/2"D	158	\$2,737.00
32012072	GST-4	4 well, LP	14,000	35"H x 58 5/8"W x 22 1/2"D	158	\$2,737.00
32012080	GST-5	5 well, Nat	17,500	35"H x 72 5/8"W x 22 1/2"D	193	\$3,320.00
32012082	GST-5	5 well, LP	17,500	35"H x 72 5/8"W x 22 1/2"D	193	\$3,320.00
Hot Well with Stainless Steel Undershef and Legs						
32012010	GST-2S	2 well, Nat	7,000	35"H x 30 5/8"W x 22 1/2"D	97	\$1,855.00
32012051	GST-2S	2 well, LP	7,000	35"H x 30 5/8"W x 22 1/2"D	97	\$1,855.00
32012020	GST-3S	3 well, Nat	10,500	35"H x 44 5/8"W x 22 1/2"D	125	\$2,409.00
32012061	GST-3S	3 well, LP	10,500	35"H x 44 5/8"W x 22 1/2"D	125	\$2,409.00
32012030	GST-4S	4 well, Nat	14,000	35"H x 58 5/8"W x 22 1/2"D	158	\$2,749.00
32012071	GST-4S	4 well, LP	14,000	35"H x 58 5/8"W x 22 1/2"D	158	\$2,749.00
32012040	GST-5S	5 well, Nat	17,500	35"H x 72 5/8"W x 22 1/2"D	193	\$3,320.00
32012081	GST-5S	5 well, LP	17,500	35"H x 72 5/8"W x 22 1/2"D	193	\$3,320.00
Wet Bath with Galvanized Undershef and Legs						
32012150	WGST-2	2 well, Nat	15,000	35"H x 30 5/8"W x 22 1/2"D	97	\$2,201.00
32012152	WGST-2	2 well, LP	15,000	35"H x 30 5/8"W x 22 1/2"D	97	\$2,201.00
32012160	WGST-3	3 well, Nat	15,000	35"H x 44 5/8"W x 22 1/2"D	125	\$2,462.00
32012162	WGST-3	3 well, LP	15,000	35"H x 44 5/8"W x 22 1/2"D	125	\$2,462.00
32012170	WGST-4	4 well, Nat	30,000	35"H x 58 5/8"W x 22 1/2"D	158	\$3,135.00
32012172	WGST-4	4 well, LP	30,000	35"H x 58 5/8"W x 22 1/2"D	158	\$3,135.00
32012180	WGST-5	5 well, Nat	30,000	35"H x 72 5/8"W x 22 1/2"D	193	\$3,758.00
32012182	WGST-5	5 well, LP	30,000	35"H x 72 5/8"W x 22 1/2"D	193	\$3,758.00
Wet Bath with Stainless Steel Undershef and Legs						
32012110	WGST-2S	2 well, Nat	15,000	35"H x 30 5/8"W x 22 1/2"D	97	\$2,536.00
32012151	WGST-2S	2 well, LP	15,000	35"H x 30 5/8"W x 22 1/2"D	97	\$2,536.00
32012120	WGST-3S	3 well, Nat	15,000	35"H x 44 5/8"W x 22 1/2"D	125	\$2,853.00
32012161	WGST-3S	3 well, LP	15,000	35"H x 44 5/8"W x 22 1/2"D	125	\$2,853.00
32012130	WGST-4S	4 well, Nat	30,000	35"H x 58 5/8"W x 22 1/2"D	158	\$3,581.00
32012171	WGST-4S	4 well, LP	30,000	35"H x 58 5/8"W x 22 1/2"D	158	\$3,581.00
32012140	WGST-5S	5 well, Nat	30,000	35"H x 72 5/8"W x 22 1/2"D	193	\$4,262.00
32012181	WGST-5S	5 well, LP	30,000	35"H x 72 5/8"W x 22 1/2"D	193	\$4,262.00

Cold Well Tables

Unit body constructed of heavy-duty stainless steel. Opening is 5" deep with PVC drain. Unit equipped with 1/2" poly cutting board mounted on stainless steel shelf supported by stainless steel brackets. Units available with either stainless steel legs and undershelf or coated legs and undershelf. Backed by APW's One Year Warranty. FOB Standex Dock, freight class 100.



Part Number	Model	Description	Dimensions	Weight (lbs)	Price
Stationary with Coated Steel Legs and Undershelf					
32010980	CT-2	33" Cold	35"H x 33"W x 22 1/2"D	78	\$1,442.00
32010640	CT-3	48" Cold	35"H x 48"W x 22 1/2"D	93	\$1,686.00
32010650	CT-4	63 1/2" Cold	35"H x 63 1/2"W x 22 1/2"D	118	\$2,069.00
32010660	CT-5	79" Cold	35"H x 79"W x 22 1/2"D	133	\$2,339.00
Stationary with Stainless Steel Legs and Undershelf					
32011060	CT-2S	33" Cold	35"H x 33"W x 22 1/2"D	78	\$1,436.00
32010240	CT-3S	48" Cold	35"H x 48"W x 22 1/2"D	93	\$1,844.00
32010250	CT-4S	63 1/2" Cold	35"H x 63 1/2"W x 22 1/2"D	118	\$2,257.00
32010260	CT-5S	79" Cold	35"H x 79"W x 22 1/2"D	133	\$2,722.00
Portable with Coated Steel Legs and Undershelf					
32010990	PCT-2	33" Cold	35"H x 33"W x 22 1/2"D	78	\$1,723.00
32010670	PCT-3	48" Cold	35"H x 48"W x 22 1/2"D	93	\$1,774.00
32010680	PCT-4	63 1/2" Cold	35"H x 63 1/2"W x 22 1/2"D	118	\$2,117.00
32010690	PCT-5	79" Cold	35"H x 79"W x 22 1/2"D	133	\$2,761.00
Portable with Stainless Steel Legs and Undershelf					
Contact CS	PCT-2S	33" Cold	35"H x 33"W x 22 1/2"D	78	\$1,969.00
32010270	PCT-3S	48" Cold	35"H x 48"W x 22 1/2"D	93	\$2,313.00
32010280	PCT-4S	63 1/2" Cold	35"H x 63 1/2"W x 22 1/2"D	118	\$2,719.00
32010290	PCT-5S	79" Cold	35"H x 79"W x 22 1/2"D	133	\$3,182.00

Solid Top Tables

Unit body constructed of heavy-duty stainless steel. Top is 16 gauge stainless steel reinforced with channel braces for a durable work surface. Unit equipped with 1/2" poly cutting board mounted on stainless steel shelf supported by stainless steel brackets. Units available with either stainless steel legs and undershelf or coated legs and undershelf. Backed by APW's One Year Warranty. FOB Standex Dock, freight class 100.



Part Number	Model	Description	Dimensions	Weight (lbs)	Price
Stationary with Coated Steel Legs and Undershelf					
32011000	WT-3	48" Solid	35"H x 48"W x 22 1/2"D	85	\$1,280.00
32011010	WT-4	63 1/2" Solid	35"H x 63 1/2"W x 22 1/2"D	105	\$1,514.00
32010570	WT-5	79" Solid	35"H x 79"W x 22 1/2"D	125	\$1,882.00
Stationary with Stainless Steel Legs and Undershelf					
32011020	WT-3S	48" Solid	35"H x 48"W x 22 1/2"D	85	\$1,404.00
32011030	WT-4S	63 1/2" Solid	35"H x 63 1/2"W x 22 1/2"D	105	\$1,666.00
32011040	WT-5S	79" Solid	35"H x 79"W x 22 1/2"D	125	\$2,178.00
Portable with Coated Steel Legs and Undershelf					
32010540	PWT-3	48" Solid	35"H x 48"W x 22 1/2"D	90	\$1,706.00
32010560	PWT-4	63 1/2" Solid	35"H x 63 1/2"W x 22 1/2"D	110	\$1,953.00
32010590	PWT-5	79" Solid	35"H x 79"W x 22 1/2"D	130	\$2,186.00
Portable with Stainless Steel Legs and Undershelf					
32010530	PWT-3S	48" Solid	35"H x 48"W x 22 1/2"D	90	\$1,876.00
32010550	PWT-4S	63 1/2" Solid	35"H x 63 1/2"W x 22 1/2"D	110	\$2,162.00
32010580	PWT-5S	79" Solid,	35"H x 79"W x 22 1/2"D	130	\$2,655.00

Champion SERIES

Champion Series Steam Table Accessories

All accessories can be mounted facing either direction for greater flexibility.

Top - Polished stainless steel
Cutting Board - 7 1/2" wide x 1/2" thick poly; mountable on both sides of unit

Controls/Elements - Infinite controls offer high/low extra strength selections; indicator light remains on while control is in ON position; 500 watt element standard in 120V exposed well and 750 watt element standard in 208V and 240V exposed well; 750 watt element standard in sealed well. Larger elements are available as an option

7 1/2" Plate/Dish Shelf

Drain Assembly with ball valve attached on sealed wells

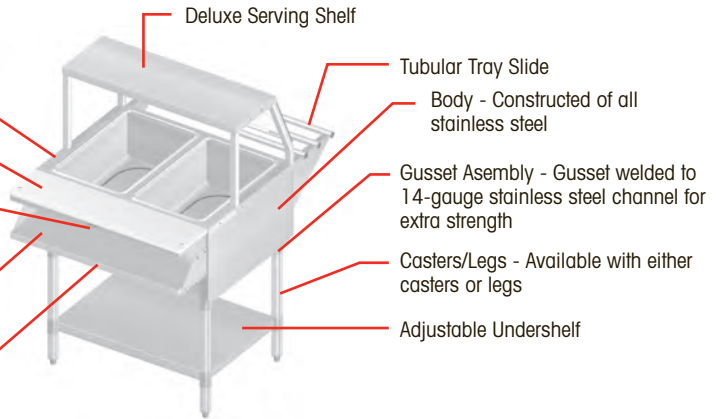

Part No.	Description	Price
32010185	Stainless Steel Pans	\$175.00
32010195	Aluminum Pans	\$174.00
32010208	Roll Top Cover	\$247.00
Specify Autofill Option (price per well)		Add \$706.00
Poly Cutting Boards (Includes all mounting parts)		
32010631	2 Well Exposed	\$394.00
32010635	2 Well Sealed	\$394.00
32010632	3 Well Exposed	\$434.00
32010636	3 Well Sealed	\$434.00
32010633	4 Well Exposed	\$500.00
32010637	4 Well Sealed	\$500.00
32010634	5 Well Exposed	\$655.00
32010638	5 Well Sealed	\$655.00
32010681	48" Cold Table & Solid Top	\$477.00
32010682	63.5" Cold Table & Solid Top	\$548.00
32010683	79" Cold Table & Solid Top	\$654.00
Hardwood Cutting Boards (Includes all mounting parts)		
32010651	2 Well Exposed	\$394.00
32010655	2 Well Sealed	\$394.00
32010652	3 Well Exposed	\$434.00
32010656	3 Well Sealed	\$434.00
32010653	4 Well Exposed	\$500.00
32010657	4 Well Sealed	\$500.00
32010654	5 Well Exposed	\$655.00
32010658	5 Well Sealed	\$655.00
Contact CS	48" Cold Table & Solid Top	\$477.00
Contact CS	63.5" Cold Table & Solid Top	\$548.00
Contact CS	79" Cold Table & Solid Top	\$654.00
Richlite® Cutting Boards (Includes all mounting parts)		
32010641	2 Well Exposed	\$520.00
32010645	2 Well Sealed	\$520.00
32010642	3 Well Exposed	\$651.00
32010646	3 Well Sealed	\$651.00
32010643	4 Well Exposed	\$698.00
32010647	4 Well Sealed	\$698.00
32010644	5 Well Exposed	\$842.00
32010648	5 Well Sealed	\$842.00
32010684	48" Cold Table & Solid Top	\$644.00
Contact CS	63.5" Cold Table & Solid Top	\$689.00
Contact CS	79" Cold Table & Solid Top	\$773.00
Serving Shelves with Open Front		
32010511	2 Well Exposed	\$774.00
32010515	2 Well Sealed	\$774.00
32010512	3 Well Exposed	\$867.00
32010516	3 Well Sealed	\$867.00
32010513	4 Well Exposed	\$928.00
32010517	4 Well Sealed	\$928.00
32010514	5 Well Exposed	\$1,183.00
32010518	5 Well Sealed	\$1,183.00
32010539	48" Cold Table & Solid Top	\$610.00
Contact CS	63.5" Cold Table & Solid Top	\$658.00
Contact CS	79" Cold Table & Solid Top	\$837.00

Part No.	Description	Price
Serving Shelves with Acrylic Shield		
32010501	2 Well Exposed	\$859.00
32010505	2 Well Sealed	\$859.00
32010502	3 Well Exposed	\$957.00
32010506	3 Well Sealed	\$957.00
32010503	4 Well Exposed	\$1,047.00
32010507	4 Well Sealed	\$1,047.00
32010504	5 Well Exposed	\$1,349.00
32010508	5 Well Sealed	\$1,349.00
32010509	48" Cold Table & Solid Top	\$788.00
32010519	63.5" Cold Table & Solid Top	\$929.00
32010529	79" Cold Table & Solid Top	\$1,072.00
Deluxe Glass Serving Shelves		
32010127	2 Well Exposed	\$1,153.00
32010167	2 Well Sealed	\$1,153.00
32010137	3 Well Exposed	\$1,191.00
32010177	3 Well Sealed	\$1,191.00
32010147	4 Well Exposed	\$1,324.00
32010187	4 Well Sealed	\$1,324.00
32010157	5 Well Exposed	\$1,691.00
32010197	5 Well Sealed	\$1,691.00
32010305	48" Cold Table & Solid Top	\$1,077.00
32010315	63.5" Cold Table & Solid Top	\$1,122.00
32010325	79" Cold Table & Solid Top	\$1,260.00
Buffet Shelves with One Side Sneeze Guard		
32010472	2 Well Exposed	\$1,051.00
32010476	2 Well Sealed	\$1,051.00
32010473	3 Well Exposed	\$1,101.00
32010477	3 Well Sealed	\$1,101.00
32010474	4 Well Exposed	\$1,229.00
32010478	4 Well Sealed	\$1,229.00
32010475	5 Well Exposed	\$1,341.00
32010479	5 Well Sealed	\$1,341.00
32010445	48" Cold Table & Solid Top	\$1,024.00
32010446	63.5" Cold Table & Solid Top	\$1,080.00
32010447	79" Cold Table & Solid Top	\$1,161.00
Buffet Shelves with Sneeze Guard on Both Sides		
32010348	2 Well Exposed	\$1,088.00
32010308	2 Well Sealed	\$1,088.00
32010358	3 Well Exposed	\$1,149.00
32010318	3 Well Sealed	\$1,149.00
32010368	4 Well Exposed	\$1,275.00
32010328	4 Well Sealed	\$1,275.00
32010378	5 Well Exposed	\$1,400.00
32010338	5 Well Sealed	\$1,400.00
32010376	48" Cold Table & Solid Top	\$1,062.00
32010388	63.5" Cold Table & Solid Top	\$1,101.00
32010398	79" Cold Table & Solid Top	\$1,246.00
Buffet Shelves with One Side Sneeze Guard & Lights		
32010482	2 Well Exposed	\$1,532.00
32010486	2 Well Sealed	\$1,532.00
32010483	3 Well Exposed	\$1,600.00
32010487	3 Well Sealed	\$1,600.00
32010484	4 Well Exposed	\$2,134.00
32010488	4 Well Sealed	\$2,134.00
32010485	5 Well Exposed	\$2,481.00
32010489	5 Well Sealed	\$2,481.00
Contact CS	48" Cold Table & Solid Top	\$1,075.00
Contact CS	63.5" Cold Table & Solid Top	\$1,276.00
Contact CS	79" Cold Table & Solid Top	\$1,405.00

Part No.	Description	Price
Buffet Shelves with Sneeze Guard on Both Sides and Lights		
32010492	2 Well Exposed	\$1,574.00
32010496	2 Well Sealed	\$1,574.00
32010493	3 Well Exposed	\$1,644.00
32010497	3 Well Sealed	\$1,644.00
32010494	4 Well Exposed	\$2,186.00
32010498	4 Well Sealed	\$2,186.00
32010495	5 Well Exposed	\$2,540.00
32010499	5 Well Sealed	\$2,540.00
Contact CS	48" Cold Table & Solid Top	\$1,284.00
Contact CS	63.5" Cold Table & Solid Top	\$1,409.00
Contact CS	79" Cold Table & Solid Top	\$1,533.00
Stainless Steel Solid Tray Slide (Flat Surface)		
32010521	2 Well Exposed	\$684.00
32010525	2 Well Sealed	\$684.00
32010522	3 Well Exposed	\$832.00
32010526	3 Well Sealed	\$832.00
32010523	4 Well Exposed	\$1,103.00
32010527	4 Well Sealed	\$1,103.00
32010524	5 Well Exposed	\$1,363.00
32010528	5 Well Sealed	\$1,363.00
Contact CS	48" Cold Table & Solid Top	\$555.00
Contact CS	63.5" Cold Table & Solid Top	\$694.00
32010589	79" Cold Table & Solid Top	\$979.00
Tray Slide - 3 Bars		
32010126	2 Well Exposed	\$510.00
32010166	2 Well Sealed	\$510.00
32010136	3 Well Exposed	\$613.00
32010176	3 Well Sealed	\$613.00
32010146	4 Well Exposed	\$832.00
32010186	4 Well Sealed	\$832.00
32010156	5 Well Exposed	\$1,032.00
32010196	5 Well Sealed	\$1,032.00
32010304	48" Cold Table & Solid Top	\$454.00
32010314	63.5" Cold Table & Solid Top	\$644.00
32010324	79" Cold Table & Solid Top	\$757.00
Dish Shelf		
32010121	2 Well Exposed	\$501.00
32010161	2 Well Sealed	\$501.00
32010131	3 Well Exposed	\$627.00
32010171	3 Well Sealed	\$627.00
32010141	4 Well Exposed	\$876.00
32010181	4 Well Sealed	\$876.00
32010151	5 Well Exposed	\$1,001.00
32010191	5 Well Sealed	\$1,001.00
32010264	48" Cold Table & Solid Top	\$559.00
32010274	63.5" Cold Table & Solid Top	\$689.00
32010284	79" Cold Table & Solid Top	\$860.00
Adjustable Overshaft		
32010469	Adj. overshaft bracket right	\$223.00
32010459	Adj. overshaft bracket left	\$223.00
32010383	2 Well Exposed	\$842.00
32010384	3 Well Exposed	\$858.00
32010385	4 Well Exposed	\$867.00
32010386	5 Well Exposed	\$902.00
32010343	2 Well Sealed	\$752.00
32010344	3 Well Sealed	\$774.00
32010345	4 Well Sealed	\$848.00
32010346	5 Well Sealed	\$863.00
Contact CS	48" Cold Table & Solid Top	\$740.00
Contact CS	63.5" Cold Table & Solid Top	\$845.00
Contact CS	79" Cold Table & Solid Top	\$932.00

Note: All exposed model accessories fit both electric and gas steam tables. Sealed model accessories cannot be used on gas steam tables.

Heavy-Duty Cookline

APW's Heavy-Duty Cookline extends the quality and reliability of our Champion Cookline to an even heavier and more robust line of kitchen equipment. Our heavy-duty CharBroilers, Griddles, Hotplates and Fryers are designed to accommodate even the most demanding of cooking environments. Ease of use and industrial-grade construction ensure a maximum return on investment for high volume kitchens.

Heavy-Duty Gas Radiant CharBroilers

Heavy-Duty Countertop Gas Radiant CharBroilers with exceptional low profile design is only 15 7/32" (387mm) to broiling surface making the Heavy-Duty series broilers ideal for use on refrigerated cabinets and a 21 1/2" deep broiling surface. Exterior front is all stainless steel with unique air blanket for ventilation and cooler outer temperatures. Front grease trough, slide out stainless steel water pan/grease drawer and 4" (102mm) chrome plated adjustable legs are standard. Interior combustion chamber is fabricated of 16 gauge CRS. If shipping via air freight, dimensional weights apply. Backed by APW's three year parts and two year labor warranty. FOB Standex Dock, freight class 70.



Part Number	Model	Description	BTU	Radiants	Dimensions	Weight (lbs)	Price
22211240	HCB-2424i	Nat	80,000	4	15 7/32"H x 24"W 33 7/8"D	167	\$4,070.00
22211242	HCB-2424i	LP	80,000	4	15 7/32"H x 24"W 33 7/8"D	167	\$4,070.00
22211360	HCB-2436i	Nat	120,000	6	15 7/32"H x 36"W 33 7/8"D	277	\$5,530.00
22211362	HCB-2436i	LP	120,000	6	15 7/32"H x 36"W 33 7/8"D	277	\$5,530.00
22211480	HCB-2448i	Nat	160,000	8	15 7/32"H x 48"W 33 7/8"D	335	\$7,112.00
22211482	HCB-2448i	LP	160,000	8	15 7/32"H x 48"W 33 7/8"D	335	\$7,112.00
22211600	HCB-2460i	Nat	200,000	10	15 7/32"H x 60"W 33 7/8"D	365	\$8,891.00
22211602	HCB-2460i	LP	200,000	10	15 7/32"H x 60"W 33 7/8"D	365	\$8,891.00
22211720	HCB-2472i	Nat	240,000	12	15 7/32"H x 72"W 33 7/8"D	613	\$10,372.00
22211722	HCB-2472i	LP	240,000	12	15 7/32"H x 72"W 33 7/8"D	613	\$10,372.00

Heavy-Duty Lava Rock CharBroilers

Heavy-Duty Countertop Lava Rock CharBroilers with exceptional low profile design is only 15 7/32" (387mm) to broiling surface making the Heavy-Duty series broilers ideal for use on refrigerated cabinets and a 21 1/2" deep broiling surface. Exterior front is all stainless steel with unique air blanket for ventilation and cooler outer temperatures. Front grease trough, slide out stainless steel water pan/grease drawer and 4" (102mm) chrome plated adjustable legs are standard. Interior combustion chamber is fabricated of 16 gauge CRS. If shipping via air freight, dimensional weights apply. Backed by APW's three year parts and two year labor warranty. FOB Standex Dock, freight class 70.



Part Number	Model	Description	BTU	Radiants	Dimensions	Weight (lbs)	Price
22221240	HCRB-2424i	Nat	80,000	4	15 7/32"H x 24"W 33 7/8"D	193	\$4,070.00
22221242	HCRB-2424i	LP	80,000	4	15 7/32"H x 24"W 33 7/8"D	193	\$4,070.00
22221360	HCRB-2436i	Nat	120,000	6	15 7/32"H x 36"W 33 7/8"D	320	\$5,530.00
22221362	HCRB-2436i	LP	120,000	6	15 7/32"H x 36"W 33 7/8"D	320	\$5,530.00
22221480	HCRB-2448i	Nat	160,000	8	15 7/32"H x 48"W 33 7/8"D	335	\$7,112.00
22221482	HCRB-2448i	LP	160,000	8	15 7/32"H x 48"W 33 7/8"D	335	\$7,112.00
22221600	HCRB-2460i	Nat	200,000	10	15 7/32"H x 60"W 33 7/8"D	430	\$8,891.00
22221602	HCRB-2460i	LP	200,000	10	15 7/32"H x 60"W 33 7/8"D	430	\$8,891.00
22221720	HCRB-2472i	Nat	240,000	12	15 7/32"H x 72"W 33 7/8"D	528	\$10,372.00
22221722	HCRB-2472i	LP	240,000	12	15 7/32"H x 72"W 33 7/8"D	528	\$10,372.00

HD Cookline SERIES

Heavy-Duty Manual Gas Griddles

Gas Countertop Griddles with a low profile design that are only 15 7/32" tall to grilling surface making them ideal for use on refrigerated cabinets or counter tops. The Heavy-Duty Series Griddles are designed to mix and match with the Heavy-Duty Char Broilers and Heavy-Duty counter top ranges. The griddle plate is 1" thick (25.4mm) and 24" deep (610mm), polished, cold-rolled steel. Six widths are available from 24" (610mm) to 72" (1829mm) in one foot increments. The Heavy-Duty Series features high-performance, energy-efficient, 32,000 BTUH burners located every 12" with individual, manual controlled valves. If shipping via air freight, dimensional weights apply. Backed by APW's three year parts and two year labor warranty. FOB Standex Dock, freight class 70.



Part Number	Model	Description	BTU	Dimensions	Weight (lbs)	Price
22241240	HMG-2424i	Nat	64,000	15 7/32"H x 24"W 33 7/8"D	308	\$3,057.00
22241242	HMG-2424i	LP	64,000	15 7/32"H x 24"W 33 7/8"D	308	\$3,057.00
22241360	HMG-2436i	Nat	96,000	15 7/32"H x 36"W 33 7/8"D	470	\$4,164.00
22241362	HMG-2436i	LP	96,000	15 7/32"H x 36"W 33 7/8"D	470	\$4,164.00
22241480	HMG-2448i	Nat	128,000	15 7/32"H x 48"W 33 7/8"D	543	\$5,321.00
22241482	HMG-2448i	LP	128,000	15 7/32"H x 48"W 33 7/8"D	543	\$5,321.00
22241600	HMG-2460i	Nat	160,000	15 7/32"H x 60"W 33 7/8"D	645	\$6,592.00
22241602	HMG-2460i	LP	160,000	15 7/32"H x 60"W 33 7/8"D	645	\$6,592.00
22241720	HMG-2472i	Nat	192,000	15 7/32"H x 72"W 33 7/8"D	770	\$8,248.00
22241722	HMG-2472i	LP	192,000	15 7/32"H x 72"W 33 7/8"D	770	\$8,248.00

Heavy-Duty Thermostatic Griddles

Gas Countertop Griddles with a low profile design that are only 15 7/32" tall to grilling surface making them ideal for use on refrigerated cabinets or counter tops. The Heavy-Duty Series Griddles are designed to mix and match with the Heavy-Duty Char Broilers and Heavy-Duty counter top ranges. The griddle plate is 1" thick (25.4mm) and 24" deep (610mm), polished, cold-rolled steel. Six widths are available from 24" (610mm) to 72" (1829mm) in one foot increments. The Heavy-Duty Series features high-performance, energy-efficient, 32,000 BTUH burners located every 12" with individual thermostatic controls. If shipping via air freight, dimensional weights apply. Backed by APW's three year parts and two year labor warranty. FOB Standex Dock, freight class 70.



Part Number	Model	Description	BTU	Dimensions	Weight (lbs)	Price
22231240	HTG-2424i	Nat	64,000	15 7/32"H x 24"W 33 7/8"D	410	\$4,573.00
22231242	HTG-2424i	LP	64,000	15 7/32"H x 24"W 33 7/8"D	410	\$4,573.00
22231360	HTG-2436i	Nat	96,000	15 7/32"H x 36"W 33 7/8"D	462	\$6,105.00
22231362	HTG-2436i	LP	96,000	15 7/32"H x 36"W 33 7/8"D	462	\$6,105.00
22231480	HTG-2448i	Nat	128,000	15 7/32"H x 48"W 33 7/8"D	552	\$7,610.00
22231482	HTG-2448i	LP	128,000	15 7/32"H x 48"W 33 7/8"D	552	\$7,610.00
22231600	HTG-2460i	Nat	160,000	15 7/32"H x 60"W 33 7/8"D	651	\$9,048.00
22231602	HTG-2460i	LP	160,000	15 7/32"H x 60"W 33 7/8"D	651	\$9,048.00
22231720	HTG-2472i	Nat	192,000	15 7/32"H x 72"W 33 7/8"D	895	\$11,939.00
22231722	HTG-2472i	LP	192,000	15 7/32"H x 72"W 33 7/8"D	895	\$11,939.00

Flat Gas Hot Plates

Heavy-Duty Flat Hot Plates with a low profile design are only 15 7/32" tall to range surface making them ideal for use on refrigerated cabinets or countertops. Heavy-Duty Series Hot Plates are designed to mix and match with the Heavy-Duty Charbroilers and Griddles. The Heavy-Duty Countertop Hot Plates feature exceptionally heavy, removable, individual cast iron top grates. Four widths are available including a 12" wide (305mm) two-burner, 24" wide (610mm) four-burner, 36" wide (915mm) six-burner and a 48" wide (1220mm) eight-burner. If shipping via air freight, dimensional weights apply. Backed by APW's three year parts and two year labor warranty. FOB Standex Dock, freight class 70.



Part Number	Model	Description	BTU	Dimensions	Weight (lbs)	Price
22261020	HHP-212i	Nat	60,000	13 13/16"H x 12"W 33 1/8"D	81	\$1,610.00
22261022	HHP-212i	LP	60,000	13 13/16"H x 12"W 33 1/8"D	81	\$1,610.00
22261040	HHP-424i	Nat	120,000	13 13/16"H x 24"W 33 1/8"D	183	\$2,301.00
22261042	HHP-424i	LP	120,000	13 13/16"H x 24"W 33 1/8"D	183	\$2,301.00
22261060	HHP-636i	Nat	180,000	13 13/16"H x 36"W 33 1/8"D	227	\$3,102.00
22261062	HHP-636i	LP	180,000	13 13/16"H x 36"W 33 1/8"D	227	\$3,102.00
22261080	HHP-848i	Nat	240,000	13 13/16"H x 48" W 33 1/8"D	256	\$3,910.00
22261082	HHP-848i	LP	240,000	13 13/16"H x 48" W 33 1/8"D	256	\$3,910.00

Stepped Gas Hot Plates

The Heavy-Duty Stepped Hot Plate with a low profile design are only 16 13/16" tall to range surface making them ideal for use on refrigerated cabinets or countertops. The Heavy-Duty Hot Plates are designed to mix and match with the Heavy-Duty Charbroilers and Griddles. The Heavy-Duty Stepped Hot Plate feature exceptionally heavy, removable, individual cast iron top grates. Four widths are available including a 12" wide (305mm) two-burner, 24" wide (610mm) four-burner, 36" wide (915mm) six-burner and a 48" wide (1220mm) eight-burner. If shipping via air freight, dimensional weights apply. Backed by APW's Three Year Parts, Two Year Labor Warranty. FOB Standex Dock, freight class 70.



Part Number	Model	Description	BTU	Dimensions	Weight (lbs)	Price
22271020	HHPS-212i	Nat	60,000	16 13/16"H x 12"W 30 7/8"D	86	\$1,813.00
22271022	HHPS-212i	LP	60,000	16 13/16"H x 12"W 30 7/8"D	86	\$1,813.00
22271040	HHPS-424i	Nat	120,000	16 13/16"H x 24"W 30 7/8"D	188	\$2,708.00
22271042	HHPS-424i	LP	120,000	16 13/16"H x 24"W 30 7/8"D	188	\$2,708.00
22271060	HHPS-636i	Nat	180,000	16 13/16"H x 36"W 30 7/8"D	245	\$3,493.00
22271062	HHPS-636i	LP	180,000	16 13/16"H x 36"W 30 7/8"D	245	\$3,493.00
22271080	HHPS-848i	Nat	240,000	16 13/16"H x 48"W 30 7/8"D	267	\$4,622.00
22271082	HHPS-848i	LP	240,000	16 13/16"H x 48"W 30 7/8"D	267	\$4,622.00

Heavy-Duty Electric Fryers

Heavy-Duty electric fryers are compact design with high output capabilities. The fryers reach frying temperatures quickly while maintaining heat levels from one load to the next. Features include; cycling lights to alert operators that the unit is ready for the next batch of food product, stainless steel construction and high limit protection control circuit breaker which automatically trips should frying compound overheat. If shipping via air freight, dimensional weights apply. Backed by APW's One Year Warranty. FOB Standex Dock, freight class 85.



Part Number	Model	Description	Electric	Dimensions	Weight (lbs)	Price
22291150	HEF-15Si	Fryer 15lb Heavy-Duty	208/240V	17 9/16"H x 12"W x 31 1/32"D	36	\$2,296.00
22293150	HEF-15Si	Fryer 15lb Heavy-Duty	230V	17 9/16"H x 12"W x 31 1/32"D	36	\$2,296.00
22291300	HEF-30Ti	Fryer 30lb Heavy-Duty	208/240V	17 9/16"H x 24"W x 31 1/32"D	92	\$3,958.00
22293300	HEF-30Ti	Fryer 30lb Heavy-Duty	230V	17 9/16"H x 24"W x 31 1/32"D	92	\$3,958.00

Heavy-Duty Stands

Heavy-duty cooking stands constructed of stainless steel top shelf, aluminized bottom shelf and galvanized legs. Available from 24" to 72" sizes, designed to hold individual or multiple units of Heavy-Duty Cookline. If shipping via air freight, dimensional weights apply. Backed by APW's One Year Warranty. FOB Standex Dock, freight class 85.



Part Number	Model	Description	Dimensions	Weight (lbs)	Price
232400	HDS-24L	with legs	24 1/2"H x 24"W x30"D	50	\$1,390.00
232401	HDS-24C	with casters	24 1/2"H x 24"W x30"D	48	\$1,625.00
233600	HDS-36L	with legs	24 1/2"H x 36"W x30"D	59	\$1,547.00
233601	HDS-36C	with casters	24 1/2"H x 36"W x30"D	57	\$1,782.00
234800	HDS-48L	with legs	24 1/2"H x 48"W x30"D	71	\$1,757.00
234801	HDS-48C	with casters	24 1/2"H x 48"W x30"D	69	\$1,991.00
236000	HDS-60L	with legs	24 1/2"H x 60"W x30"D	80	\$2,033.00
236001	HDS-60C	with casters	24 1/2"H x 60"W x30"D	78	\$2,270.00
237200	HDS-72L	with legs	24 1/2"H x 72"W x30"D	89	\$2,166.00
237201	HDS-72C	with casters	24 1/2"H x 72"W x30"D	87	\$2,406.00

Toaster SERIES

Energy Saving, Radiant Conveyor & Bun Grill Contact Toasters

APW's eco-friendly, ECO-4000 radiant Conveyor Toasters reduce energy consumption while saving money and delivering superior toasting capability. APW's Bun Grill toasters are made with removable side panels for easy service access. All APW Toasters are constructed of stainless steel with durable metal-sheathed heating elements, high-temperature insulation, wiring and bearings to guarantee dependability and durability.

ECO-4000 Energy Saving Toaster

The ECO-4000 was designed from the ground up to start fast, save electricity, produce perfect toast, and work well in the front or back of the house. It saves approximately 40% more energy than competitive products, with programmable electronic intelligence that gives Toast Now rapid response, adjustable cycling for any quantities or types of toasting products. Bread, bagels, muffins, you name it – the ECO-4000 can toast it to perfection. Backed by APW's One Year Warranty, FOB Standex Dock, freight class 100.



Part Number	Model	Electric	Dimensions	Weight (lbs)	Price
21851470	ECO4000 350E	120V, 1725W, 14.4 Amps	15 1/16"H X 14 13/16"W X 23 1/2"D	54	\$2,359.00
21851490	ECO4000 350L	120V, 1725W, 14.4 Amps	15 1/16"H X 14 13/16"W X 23 1/2"D	54	\$1,592.00
21851400	ECO4000 500E	208V, 2800W, 13.6 Amps	15 1/16"H X 14 13/16"W X 23 1/2"D	54	\$2,659.00
21851401	ECO4000 500E	240V, 2800W, 11.7 Amps	15 1/16"H X 14 13/16"W X 23 1/2"D	54	\$2,659.00
21851480	ECO4000 500L	208V, 2800W, 13.6 Amps	15 1/16"H X 14 13/16"W X 23 1/2"D	54	\$2,153.00
21851402	ECO4000 500L	240V, 2800W, 11.7 Amps	15 1/16"H X 14 13/16"W X 23 1/2"D	54	\$2,153.00

E = Digital; L = Analog

AT Express Radiant Conveyor Toasters

The AT Express small footprint toaster is standard with front loading, variable speed control, superfeeder, and 1 1/2" high product opening. 10" wide conveyor belt. Produces over 300 slices per hour. If shipping via air freight, dimensional weights apply. Backed by APW's Two Year Warranty. FOB Standex Dock, freight class 100.



Part Number	Model	Electric	Dimensions	Weight (lbs)	Price
93300000	AT EXPRESS	120V, 1725W, 14.4 Amps, 60hz	13 9/32"H x 14 3/4"W x 18"D	35	\$1,457.00
93300001	AT EXPRESS	208V, 1725W, 8.3 Amps, 60hz	13 9/32"H x 14 3/4"W x 18"D	35	\$1,457.00
93300002	AT EXPRESS	240V, 1725W, 7.2 Amps, 60hz	13 9/32"H x 14 3/4"W x 18"D	35	\$1,457.00
Export Model					
93300005-CE	AT EXPRESS	230V, 1725W, 7.5 Amps, 50hz	13 9/32"H x 14 3/4"W x 18"D	35	\$1,457.00

X*TREME® -1 Radiant Conveyor Toasters

X*TREME®-1 Radiant Conveyor Toaster is standard with variable speed control, superfeeder, and 1-1/2" high product opening. 10" wide conveyor belt. Produces over 350 slices per hour. Power Saver Switch and lighted rocker switches. Special Cool to the Touch guards in the front and Cool to the Touch surfaces. If shipping via air freight, dimensional weights apply. Backed by APW's Two Year Warranty. FOB Standex Dock, freight class 100.



Part Number	Model	Electric	Dimensions	Weight (lbs)	Price
93100170-BLACK	XTRM-1	120V, 1725W, 14.4 Amps, 60hz	13 1/4"H x 15 3/6"W x 17 3/4"D	35	\$1,646.00
93100173-BLACK	XTRM-1	208V, 1725W, 8.2 Amps, 60hz	13 1/4"H x 15 3/6"W x 17 3/4"D	35	\$2,137.00
93100171-BLACK	XTRM-1	240V, 1725W, 7.2 Amps, 60hz	13 1/4"H x 15 3/6"W x 17 3/4"D	35	\$2,137.00
Export Model					
93100172-BLACK	XTRM-1	230V, 1725W, 7.5 Amps, 50hz	13 1/4"H x 15 3/6"W x 17 3/4"D	35	\$2,137.00

Toaster SERIES

X*TREME® -2 10" Wide Radiant Conveyor Toasters

The XTRM-2 10" Wide Radiant Conveyor Toaster incorporates all of the technologically advanced features of the industry's leading toaster line and combines it with the new stylized "X-Treme" exterior. Produce toast in less than 30 seconds, for more than 800 slices of toast per hour! Variable speed controls combined with top and bottom heat controls give you "X-treme" versatility to handle all types of breads, muffins or bagels. Super feeder and power saver stand-by control are standard. Thermostatically controlled fan combined with high temperature insulation provide the maximum safety for your employees. Available in a 1 1/2" or 3" opening. Specify voltage. If shipping via air freight, dimensional weights apply. Backed by APW's Two Year Warranty. FOB Standex Dock, freight class 100.



Part Number	Model	Electric	Dimensions	Weight (lbs)	Price
Standard Opening					
93302000	XTRM-2	208V, 2840W, 13.7 Amps	14 3/4"H x 15 5/8"W x 23 21/64"D	50	\$2,520.00
93302040	XTRM-2	240V, 2840W, 11.8 Amps	14 3/4"H x 15 5/8"W x 23 21/64"D	50	\$2,520.00
93302005-CE	XTRM-2	230V, 2840W, 12.3 Amps	14 3/4"H x 15 5/8"W x 23 21/64"D	50	\$2,693.00
3" High Opening					
93302300	XTRM-2H	208V, 2840W, 13.7 Amps	14 3/4"H x 15 5/8"W x 23 21/64"D	54	\$2,693.00
93302340	XTRM-2H	240V, 2840W, 11.8 Amps	14 3/4"H x 15 5/8"W x 23 21/64"D	54	\$2,693.00
93302305-CE	XTRM-2H	230V, 2840W, 12.3 Amps	14 3/4"H x 15 5/8"W x 23 21/64"D	54	\$2,693.00
Options					
93000207		Stacking Kit		5	\$253.00

X*TREME® -3 13" Wide Radiant Conveyor Toasters

The XTRM-3 13" Wide Radiant Conveyor Toaster provides a 13" wide "X-treme" wide opening to allow 3 slices of toast to pass at one time. Designed to produce toast (3 slices across) in less than 30 seconds, for more that 1000 slices of toast per hour! Variable speed controls combined with top and bottom heat controls give you "X-treme" versatility to handle all types of breads, bagels or muffins. Super feeder and power saver stand-by control are standard. Thermostatically controlled fan combined with high temperature insulation provide the maximum safety for your employees. Available in a 1 1/2" or 3" opening. Specify voltage. If shipping via air freight, dimensional weights apply. Backed by APW's Two Year Warranty. FOB Standex Dock, freight class 100.



Part Number	Model	Electric	Dimensions	Weight (lbs)	Price
Standard Opening					
93303000	XTRM-3	208V, 3340W, 16 Amps	14 3/4"H x 18 5/8"W x 23 21/64"D	56	\$3,115.00
93303040	XTRM-3	240V, 3340W, 14 Amps	14 3/4"H x 18 5/8"W x 23 21/64"D	56	\$3,115.00
93303003-CE	XTRM-3	230V, 3340W, 14 Amps	14 3/4"H x 18 5/8"W x 23 21/64"D	56	\$3,115.00
3" High Opening					
93303300	XTRM-3H	208V, 3340W, 16 Amps	15 3/4"H x 18 5/8"W x 23 21/64"D	62	\$3,250.00
93303340	XTRM-3H	240V, 3340W, 14 Amps	15 3/4"H x 18 5/8"W x 23 21/64"D	62	\$3,250.00
93303303-CE	XTRM-3H	230V, 3340W, 14 Amps	15 3/4"H x 18 5/8"W x 23 21/64"D	62	\$3,250.00
Options					
93200220		Stacking Unit		5	\$253.00

Fastrac 1000 Toasters

Fastrac 1000 generates more than 1000 slices of toast per hour without increasing the width to a 3 wide toaster. (16% less width on the counter vs. competition) comes standard with variable speed controls, power saver switch, thermostatically controlled fan, "cool to the touch" exteriors and super feeder. Available in a 1 1/2" or 3" opening. Specify voltage. If shipping via air freight, dimensional weights apply. Backed by APW's One Year Warranty. FOB Standex Dock, freight class 100.



Part Number	Model	Description	Electric	Dimensions	Weight (lbs)	Price
FT1000-C	FT-1000	1 1/2" Opening	208V, 3300W, 15.9 Amps	14 3/5"H x 16 1/5"W x 26 1/2"D	48	\$3,096.00
FT1000-E	FT-1000	1 1/2" Opening	240V, 3300W, 13.8 Amps	14 3/5"H x 16 1/5"W x 26 1/2"D	48	\$3,096.00
FT1000H-C	FT-1000H	3" Opening	208V, 3300W, 15.9 Amps	16 1/10"H x 16 1/5"W x 26 1/2"D	53	\$3,309.00
FT1000H-E	FT-1000H	3" Opening	240V, 3300W, 13.8 Amps	16 1/10"H x 16 1/5"W x 26 1/2"D	53	\$3,309.00

C=208V E=240V

BagelMaster Toasters

The Fastest Bagel Toaster in the industry, produces a toasted bagel half in 15 seconds. Stainless steel housing and radiant reflector. Average yield of up to 1440 bagel halves per hour. Choose from our 2" or 3" product opening. If shipping via air freight, dimensional weights apply. Backed by APW's One Year Warranty. FOB Standex Dock, freight class 100.



Part Number	Model	Electric	Dimensions	Weight (lbs)	Price
BT15C-2	BT-15-2	208V, 4600W, 22.1 Amps	18 1/2"H x 18 5/16"W x 26"D	81	\$3,286.00
BT15E-2	BT-15-2	240V, 4600W, 19.2 Amps	18 1/2"H x 18 5/16"W x 26"D	81	\$3,286.00
BT15C-3	BT-15-3	208V, 4600W, 22.1 Amps	19 1/2"H x 18 5/16"W x 26"D	86	\$3,649.00
BT15E-3	BT-15-3	240V, 4600W, 19.2 Amps	19 1/2"H x 18 5/16"W x 26"D	86	\$3,649.00
Export					
BT15F-2	BT-15-2 CE	230V, 4600W, 19.8 Amps	18 1/2"H x 18 5/16"W x 26"D	81	\$3,286.00
BT15F-3	BT-15-3 CE	230V, 4600W, 19.8 Amps	19 1/2"H x 18 5/16"W x 26"D	86	\$3,649.00
Options					
Used With					
82889/88889	COV	BT-15-2 or -3	Cover for temperature knobs		\$74.00

Toaster SERIES

M-83 Bun Grill Toasters

This Bun Grill Toaster provides optimal contact toasting and can be used with optional Superfeeder. Standard grilling cycles of 35 seconds produce 500 to 800 bun halves per hour. For dry toasting applications, PTFE sheet must be used. Specify voltage when ordering. Cannot ship UPS. If shipping via air freight, dimensional weights apply. Backed by APW's One Year Warranty. FOB Standex Dock, freight class 100.



* Super feeder & pan not included



Part Number	Model	Electric	Dimensions	Weight (lbs)	Price
83501	M-83	120V, 1600W, 13.3 Amps	20"H x 24 5/8"W x 12"D	97	\$3,679.00
83502	M-83	208V, 1600W, 7.7 Amps	20"H x 24 5/8"W x 12"D	97	\$3,850.00
83504	M-83	240V, 1600W, 6.7 Amps	20"H x 24 5/8"W x 12"D	97	\$3,850.00
Options					
85045	Slow down gear kit for field installation. Medium speed: 45-second cycle.			1/2	\$268.00
85048	26-second speed up fast gear kit.			1/2	\$282.00
85050	Slow down gear kit for field installation. Slow speed: 85-second cycle.			1/2	\$176.00
89525	Superfeeder, adds 11" to toaster height			5	\$235.00
87449	PTFE Sheet Kit for wet or dry operation. Ten sheets per kit.			4	\$336.00

M-95 Bun Grill Toasters

These bun grill toasters are available in two standard models with built-in extended grill. Optional gear speeds allow grilling 1000 bun halves per hour. For M-95-3, Specify slow (45 seconds) or fast gear (22 seconds) when ordering (standard gear for M-95-3 is 35 seconds). Internal cooling fan keeps components cool for longer life. For dry toasting applications, PTFE sheet must be used. Super feeder included. Cannot ship UPS. If shipping via air freight, dimensional weights apply. Backed by APW's One Year Warranty. FOB Standex Dock, freight class 100.



Part Number	Model	Electric	Dimensions	Weight (lbs)	Price
M952CC-CHI	M-95-2 (35 second gear only)	208V, 2780W, 13.4 Amps	28 15/16"H x 21 5/8"W x 16 5/16"D	97	\$3,353.00
M952CD-CHI	M-95-2 (55 second gear only)	208V, 2780W, 13.4 Amps	28 15/16"H x 21 5/8"W x 16 5/16"D	97	\$3,353.00
M952ED-CHI	M-95-2 (35 second gear only)	240V, 2780W, 11.6 Amps	28 15/16"H x 21 5/8"W x 16 5/16"D	97	\$3,353.00
M953CC001	M-95-3 (35 second gear only)	208V, 2780W, 13.4 Amps	30 1/2"H x 24 1/2"W x 17 1/2"D	105	\$3,657.00
M953EC001	M-95-3 (35 second gear only)	240V, 2780W, 11.6 Amps	30 1/2"H x 24 1/2"W x 17 1/2"D	105	\$3,657.00
CE Models					
M952FC-EUR-CE	M-95-2 Low Profile (55 sec. gear only)	230V, 50Hz, 2550W, 11.1 Amps	28 15/16"H x 21 5/8"W x 16 5/16"D	97	\$3,353.00
M953FC-EUR-CE	M-95-3FC-CE (35 sec. gear)	230V, 50Hz, 2550W, 11.1 Amps	30 1/2"H x 24 1/2"W x 17 1/2"D	105	\$3,405.00
Options Used With					
83997	M-95-2 Bun slide (Collects buns)			12	\$285.00
84177	M-95-2 PTFE Sheet Kit for wet or dry operation. Ten sheets per kit.			4	\$376.00
83994	M-95-3 Bun slide (Collects buns)			12	\$285.00
84176	M-95-3 PTFE Sheet Kit for wet or dry operation. Ten sheets per kit.			4	\$376.00
PS0007	55 Second Gear Kit			4	\$164.00

M-2000 High Speed Bun Grill Toasters

The Fastest Bun Grill Toaster in the industry! Produces a perfectly caramelized bun in 17-18 seconds when initial bun is placed in toaster. Continuously feeding buns in top slot results in a toasted bun every 6 to 7 seconds. Grills up to 1600 bun halves per hour. Super Feeder included. For dry toasting applications, PTFE sheet must be used. Cannot ship UPS. If shipping via air freight, dimensional weights apply. Backed by APW's One Year Warranty. FOB Standex Dock, freight class 100.

*Pan not included



Part Number	Model	Electric	Dimensions	Weight (lbs)	Price
M2KCPW	M-2000	208V, 2880W, 13.8 Amps	25 15/16"H x 23 1/2"W x 17 1/2"D	100	\$5,095.00
M2KEPW	M-2000	240V, 3840W, 16 Amps	25 15/16"H x 23 1/2"W x 17 1/2"D	100	\$5,095.00
Options					
PS0019	PTFE Sheet Kit for wet or dry operation. 16"x24". Ten sheets per kit.			4	\$376.00

Classic Insulated Warmer SERIES

Classic Insulated Warmers

APW's insulated Warmer Series includes a line of attractive and energy-efficient display warmers as well as back-of-the-house cooker warmers for soups, sauces and chilis. All of our classic insulated warmers are designed and constructed for ease of use and durable, long-lasting service. Insulated warmers include a one year free replacement warranty.

Classic Insulated Round Warmers

Energy Efficient design that keeps hot food at the perfect serving temperature. Designed to run either with water (best option) or dry (will not harm warmer). Available in 7 quart and 11 quart versions. Made of stainless steel in the exterior and interior. Fully insulated to protect interior controls. SP designates soup package that includes inset, hinged cover and ladle. If shipping via air freight, dimensional weights apply. FOB Standex Dock, freight class 100.



Part Number	Model	Description	Electric	Dimensions	Weight (lbs)	Price
54810	RW-1V	7 qt.	120V, 500W, 4.2 Amps	8 1/4"H x 10 1/2"D	11	\$343.00
54810-SP	RW-1V-SP	7 qt. Pkg	120V, 500W, 4.2 Amps	8 1/4"H x 10 1/2"D	11	\$460.00
54811	RW-2V	11 qt.	120V, 700W, 5.8 Amps	8 1/4"H x 12 1/2"D	13	\$374.00
54811-SP	RW-2V-SP	11 qt. Pkg	120V, 700W, 5.8 Amps	8 1/4"H x 12 1/2"D	14	\$513.00

Classic Countertop Insulated Round Cookers/Servers

High performance, fast recovery design that is perfect for re-thermalizing refrigerated soup, stews, chili or other food products served out of a round inset. Thermostatically controlled heat system provides fast heat up and recovery. Exterior and interior constructed of stainless steel. If shipping via air freight, dimensional weights apply. FOB Standex Dock, freight class 100.



Part Number	Model	Description	Electric	Dimensions	Weight (lbs)	Price
RCW71001	RCW-7	7 qt.	120V, 1000W, 8.3 Amps	10"H x 10 1/2"D	10	\$434.00
RCW71-SP	RCW-7SP	7 qt. Pkg	120V, 1000W, 8.3 Amps	10"H x 10 1/2"D	11	\$594.00
RCW111001	RCW-11	11 qt.	120V, 1200W, 10.0 Amps	10"H x 12 1/2"D	12	\$484.00
RCW111-SP	RCW-11SP	11 qt. Pkg	120V, 1200W, 10.0 Amps	10"H x 12 1/2"D	13	\$663.00

Classic Insulated Kettle Cookers & Warmers

Attractive, heavy-duty, spun aluminum kettles are great for merchandising. The CWK-1 pkg. includes inset, ladle and hinged cover. Allows cooking of either soup or chili in one unit. The WK-1V pkg. includes inset, ladle and flat cover. Provides warming power to hold pre-heated foods for a quality presentation. Both units include soup name cards and holder. If shipping via air freight, dimensional weights apply. FOB Standex Dock, freight class 100.



Part Number	Model	Description	Electric	Dimensions	Weight (lbs)	Price
56725	CWK-1 pkg.	11 qt. cooker	120V, 800W, 6.7 Amps	16"H x 13 1/2"D	20	\$1,103.00
56776		Kettle only	120V, 800W, 6.7 Amps	16"H x 13 1/2"D	16	\$909.00
56625	WK-1V pkg.	11 qt. warmer	120V, 500W, 4.2 Amps	16"H x 13 1/2"D	20	\$1,053.00
56620		Kettle only	120V, 500W, 4.2 Amps	16"H x 13 1/2"D	16	\$850.00
Export Models						
56750	CWK-1 pkg.	11 qt. cooker	240V, 800W, 3.3 Amps	16"H x 13 1/2"D	20	\$1,103.00
56747		Kettle only	240V, 800W, 3.3 Amps	16"H x 13 1/2"D	16	\$909.00
56623	WK-1V pkg.	11 qt. warmer	240V, 660W, 2.7 Amps	16"H x 13 1/2"D	20	\$1,053.00
56619		Kettle only	240V, 660W, 2.7 Amps	16"H x 13 1/2"D	16	\$850.00

Classic Insulated Warmer SERIES

X*PERT™ Series Classic Insulated 12"x 20" Warmers

Energy Efficient Design that keeps hot food at the perfect serving temperature. Made of heavy-duty stainless steel. Designed to run either with water (best option) or dry (will not harm warmer). Unique heat system evenly distributes heat. Insulated to protect interior parts and countertops from heat build up. Steel element support stabilizes heating element and reflects heat toward food. Infinite temperature control. Domestic models feature "Enhanced Warranty" service. If shipping via air freight, dimensional weights apply. Backed by APW's One Year Warranty. FOB Standex Dock, freight class 100.



Part Number	Model	Description	Electric	Dimensions	Weight (lbs)	Price
21874000	W-3Vi	22 qt.	120V, 1200W, 10 Amps	9 3/4"H x 14"W x 22"D	21	\$419.00
21874100	W-3Vi	22 qt.	208/240/277V, 900/1200/1600W	9 3/4"H x 14"W x 22"D	21	\$419.00
Export Models (UL Sanitation Only)						
21874600	W-3Vi-CE	22 qt.	230V, 1100W, 4.8 Amps	9 3/4"H x 14"W x 22"D	21	\$466.00

Classic Insulated 12"x 27" Warmers

Provides over 35% more serving space for the same amount of counter front. Fits four 1/3 size pans. Heats all foods evenly. Included in the "Enhanced Warranty" service. If shipping via air freight, dimensional weights apply. Backed by APW's One Year Warranty. FOB Standex Dock, freight class 100.



Part Number	Model	Description	Electric	Dimensions	Weight (lbs)	Price
57599	W-43V	28 1/2 qt.	120V, 1500W, 12.5A	9 1/8"H x 14 11/16"W x 29 5/8"D	30	\$491.00
57598	W-43V	28 1/2 qt.	208/240V, 1200/1600W	9 1/8"H x 14 11/16"W x 29 5/8"D	30	\$491.00
Export Models (UL Sanitation Only)						
Contact CS	W-43V-CE	28 1/2 qt.	230V, 1375W, 6A	9 1/8"H x 14 11/16"W x 29 5/8"D	30	\$544.00
57599-EUR-C	W-43V-CE	28 1/2 qt.	240V, 1500W, 6.25A	9 1/8"H x 14 11/16"W x 29 5/8"D	30	\$544.00

X*PERT™ Series Classic Insulated Cookers/Servers

High Performance, fast recovery design that is perfect for re-thermalizing refrigerated pre-cooked products, defrosting frozen soups or cooking simple foods. Use with a variety of pan sizes or adapter plates for round insets. Units feature high wattage elements and thermostatic controls. Knob guards are standard. Heavy-Duty construction. If shipping via air freight, dimensional weights apply. Backed by APW's One Year Warranty. FOB Standex Dock, freight class 100.



Part Number	Model	Description	Electric	Dimensions	Weight (lbs)	Price
55740	CW-1B	11 qt., round	120V, 800W, 6.7 Amps	10 5/8"H x 12 1/2"W x 12 1/2"D	16	\$535.00
21873000	CW-2Ai	22 qt., full size	120V, 1500W, 12.5 Amps	9 3/4"H x 14"W x 22"D	29	\$788.00
21873600	CW-2Ai	22 qt., full size	208/240V, 1200/1600W	9 3/4"H x 14"W x 22"D	29	\$917.00
57551	CW-3A (not CSA)	28 1/2 qt., 4/3 size	120V, 1800W, 15 Amps	10 1/8"H x 14 11/16"W x 29 5/8"D	30	\$932.00
Export Models (UL Sanitation only)						
55770	CW-1B	11 qt., round	240V, 800W, 3.3 Amps	10 5/8"H x 12 1/2"W x 12 1/2"D	16	\$689.00
21873400	CW-2Ai	22 qt., full size	240V, 1600W, 6.7 Amps	9 3/4"H x 14"W x 22"D	29	\$917.00
57554	CW-3A (not CSA)	28 1/2 qt., 4/3 size	208V, 1375W, 6 Amps	10 1/8"H x 14 11/16"W x 29 5/8"D	30	\$980.00

Classic Insulated Warmer SERIES

Classic Insulated Cooker Warmer Merchandisers

All units use a bimetal control, no vents on the sides. CWM-2A and -2SP are provided with drain and handles for easy portability. Soup package includes an adapter plate, two 7 qt. insets, two hinge lids with clips, and two 8 oz ladles. Backed by APW's One Year Warranty. FOB Standex Dock, freight class 100.



*CWM-2V shown

Part Number	Model	Description	Electric	Dimensions	Weight (lbs)	Price
70107240	CWM-2V	22 qt., full size w/out drain	120V, 1200W, 10.0 Amps	10 5/8"H x 14 1/2"W x 22 1/2"D	29	\$643.00
70107500	CWM-2A	22 qt., full size w/drain	120V, 1200W, 10.0 Amps	10 5/8"H x 14 1/2"W x 22 1/2"D	35	\$993.00
70107235	CWM-2SP	22 qt., full size w/drain (soup pk)	120V, 1200W, 10.0 Amps	10 1/8"H x 14 11/16"W x 29 5/8"D	35	\$1,216.00

Deluxe Multi-well Soup Warmer

Merchandise a variety of soups and/or sauces in the new 1/3 multi-well warmer. Two separate well controls allow you the flexibility to heat and hold as needed. This merchandiser will catch attention from a distance. Comes with pans, ladles and bowl holders. Available with thermostatic controls. Constructed of Stainless Wrapper and Well Pan. Backed by APW's One Year Warranty. FOB Standex Dock, freight class 100.



Part Number	Model	Description	Electric	Dimensions	Weight (lbs)	Price
59020	W-9iSP	One 1/3 pan	120V, 350W, 3 Amps	11 13/16"H x 8 5/8"W x 14 5/8"D	25	\$1,304.00
59021	W-9iSP2	Two 1/3 pans	120V, 700W, 3 Amps	11 13/16"H x 17 13/16"W x 14 5/8"D	25	\$1,890.00
59022	W-9iSP3	Three 1/3 pans	120V, 1050W, 3 Amps	11 13/16"H x 25 13/13"W x 14 5/8"D	25	\$2,439.00
Options						
59394		Bowl Holder, 1-Well				\$77.00
59094		Bowl Holder, 2-Well				\$90.00
59294		Bowl Holder, 3-Well				\$102.00
2420800		Pan 1/6 Size 6" deep				\$55.00
2420810		Lid 1/6 Size				\$38.00
2420900		Pan 1/3 Size 6" deep				\$99.00
2420910		Lid 1/3 Size				\$66.00
2421000		Ladle				\$73.00

Classic Insulated Dual 4Qt Warmer

Great for kitchens, buffets, counters and dining rooms, the W4-2 dual 4 quart warmer is compact, portable, easy to maintain and inexpensive. Can be used wet or dry to keep moist foods (stews, soups, vegetables, etc.) at ideal serving temperature. Constructed with heavy-duty stainless steel. Backed by APW's One Year Warranty. FOB Standex Dock, freight class 100.



Part Number	Model	Description	Electric	Dimensions	Weight (lbs)	Price
56681	W4-2	8 qt.	120V, 800W, 4.8 Amps	8 1/4"H x 18 1/2"W x 9 1/2"D	10	\$662.00

Classic Insulated Warmer SERIES

Fractional Countertop Warmers

Energy Efficient Designs that fit into restricted countertop areas. Warmers are excellent for holding warm sauces near kitchen preparation or by self serve operations. W-4B is not CSA approved. If shipping via air freight, dimensional weights apply. Backed by APW's One Year Warranty. FOB Standex Dock, freight class 100.



*pumps and covers not available.

Part Number	Model	Description	Electric	Dimensions	Weight (lbs)	Price
56607	W-4B	4 qt.	120V, 400W, 3.3 Amps	8 5/8"H x 9 1/2"W x 9 1/2"D	9	\$457.00
56622	W-4B PKG (ULSAN)	Unlighted	120V, 396W, 3.3 Amps	10 3/4"H x 9 1/2"W x 9 1/2"D	11	\$507.00
56914	W-9	7 qt., 1/3 size	120V, 400W, 3.3 Amps	10 1/4"H x 14 1/4"W x 8 1/2"D	18	\$956.00
56911	W-12	11 qt., 1/2 size	120V, 800W, 6.7 Amps	10 1/4"H x 14 1/4"W x 12"D	20	\$820.00
56922	W-6	15 qt., 2/3 size	120V, 800W, 6.7 Amps	10 1/4"H x 14 1/4"W x 15 1/4"D	25	\$850.00
56968	W-6	15 qt., 2/3 size	240V, 800W, 3.4 Amps	10 1/4"H x 14 1/4"W x 15 1/4"D	25	\$850.00
Options						
21765700	Use with W-4B		Decal, Hof Cheesy Nachos			\$44.00
21765900	Use with W-4B		Decal, Hof Buttery Popcorn			\$44.00
21766100	Use with W-4B		Decal, Hof Fudge			\$44.00
21765800	Use with W-4B		Decal, Hof Dog Chili Topping (paste style only)			\$44.00

Classic Warmer Accessories

Customize your operation with adapter plates with a variety of configurations. 12 x 20 adapter plates fit over the top edges of countertop warmers to protect against food dripping into well area. If shipping via air freight, dimensional weights apply. FOB Standex Dock, freight class 85.

Part Number	Description	Case	Weight (lbs)	Price
Adapter Plates To Convert 12" X 20" Countertop Warmer Openings				
14880	One 7 qt. and One 11 qt.	1	4	\$142.00
14883	Two 7 qt.	1	4	\$142.00
14886	Three 4 qt.	1	4	\$142.00
14890	Four 2 1/2 qt. insets	1	4	\$142.00
14891	Four 2 1/2 qt. holes for W3Vi and CW-2Ai	1	4	\$142.00
Adapter Plates To Convert 12" X 27" Countertop Warmer Openings				
56639	Two 11 qt.	1	4	\$142.00
56638	Three 7 qt.	1	4	\$142.00
56640	Four 4 qt.	1	4	\$142.00
Converts CW1-B To Accept 7 Qt. & 4 Qt. Insets				
55707	8 1/2" hole, accepts 7 qt. inset	1	2	\$92.00
55704	6 1/2" hole, accepts 4 qt. inset	1	2	\$92.00
21365	4 qt. inset	1	2	\$102.00
56847	4 qt. slotted hinge cover w/clips	1	1	\$66.00
Converts 11 Qt. Soup Kettle To 7 Qt.				
55708	8 1/2" hole	1	2	\$90.00
55715	Converts 11 qt. to 7 qt. for RW-2V	1	2	\$90.00
7 Quart Warmers/Cookers/Kettles				
21385	Inset	1	2	\$137.00
23780	Hinged cover with clips	1	2	\$88.00
11 Quart Warmers/Cookers/Kettles				
21395	Inset	1	2	\$129.00
23790	Hinged cover with clips	1	2	\$108.00
Ladles				
57387	4 oz ladle	1	1	\$29.00
56834	1 oz ladle	1	1	\$27.00



55707



55704

14883



23790



56834

55708



Classic Warmer

SERIES

Classic Warmers

APW's Classic Warmers are designed to provide energy-efficient warming solutions, extending the safe-temperature holding life of multi-batch food items including fries, rings, pizzas, fried pies and any other warm serve items. All classic warmers are designed and constructed for ease of use and durable, long-lasting service.

Classic C*Radiant™ Countertop Fry Holding Stations

The C*Radiant™ CFHS line is designed to provide the most effective "top and bottom" heat to keep Fried Foods at the optimum temperature over a longer period of time. The C*Radiant™ CFHS line includes 21" wide and 16" wide portable models. Top Heat is provided by a system of ceramic heaters that efficiently heat foods without continuing to cook them. Thermostatically controlled heated base provides uniform holding temperatures from below. Two 40 Watt coated bulbs light up the bin area, making an attractive display of product. Perforated Bin is included in both. The C*Radiant™ CFHS-21 includes a standard Fry Bag Holding Ribbon. If shipping via air freight, dimensional weights apply. Backed by APW's One Year Warranty. FOB Standex Dock, freight class 100.



Part Number	Model	Description	Electric	Dimensions	Weight (lbs)	Price
95100000	CFHS-16	16" Fry Holding Station	120V, 1130W, 6.0 Amps	21 3/8"H x 16 1/2"W x 21 15/16"D	56	\$2,223.00
95010000	CFHS-21	21" Fry Holding Station	120V, 1430W, 12.0 Amps	21 1/4"H x 21 3/8"W x 26 7/8"D	68	\$2,589.00

Classic Countertop Display Warmers

Attractively styled, these Warmers are designed to keep food warm before serving. All styles come with cord and plug. PD-1A comes without lights. HL-1A has adjustable height. Note: Model PD-1A is not cUL Listed. Warmers shown with pans (not included). If shipping via air freight, dimensional weights apply. Backed by APW's One Year Warranty. FOB Standex Dock, freight class 100.



PD-1A



DW-1A



*Pan not included

Part Number	Model	Description	Electric	Dimensions	Weight (lbs)	Price
75425	DW-1A	Free-standing w/base	120V, 500W, 4.2 Amps	28 1/2"H x 13"W x 19 2/3"D	15	\$426.00
75441	DW-1A	Free-standing w/base	240V, 500W, 2.3 Amps	28 1/2"H x 13"W x 19 2/3"D	15	\$426.00
75401	HL-1A	Counter mount w/o base	120V, 500W, 4.2 Amps,	26 1/4"H x 6"W x 19 2/3"D	15	\$433.00
75440	HL-1A	Counter mount w/o base	240V, 500W, 2.0 Amps	26 1/4"H x 6"W x 19 2/3"D	15	\$433.00
75452	PD-1A	Free-standing w/base	120V, 575W, 4.8 Amps	17"H x 13 1/4"W x 23 3/4"D	16	\$552.00
75500	PD-1A	Free-standing w/base	240V, 575W, 2.3 Amps	17"H x 13 1/4"W x 23 3/4"D	16	\$552.00
Export Models						
Contact CS	DW-1A	Free-standing w/base	230V, 500W, 2 Amps	28 1/2"H x 13"W x 19 2/3"D	15	\$434.00
Contact CS	HL-1A	Counter mount w/o base	230V, 500W, 2 Amps	26 1/4"H x 6"W x 19 2/3"D	15	\$439.00
75500-EUR-CE	PD-1A	Free-standing w/base	230V, 575W, 2.3 Amps	17"H x 13 1/4"W x 23 3/4"D	16	\$571.00

Classic Warmer

SERIES

Classic Warming Shelves

Five different sizes available to match your space requirements. All stainless steel with infinite control. Six-foot cord and plug included. 208/240V available. Please specify voltage. Model WS-6 cannot ship UPS. If shipping via air freight, dimensional weights apply. Backed by APW's One Year Warranty. FOB Standex Dock, freight class 100.



Part Number	Model	Description	Electric	Dimensions	Weight (lbs)	Price
21670524	WS-2	24" surface	120V, 200W, 1.7 Amps	2 3/8"H x 18"W x 24"L	27	\$860.00
21671024	WS-2	24" surface	208V, 200W, 1 Amps	2 3/8"H x 18"W x 24"L	27	\$860.00
21671124	WS-2	24" surface	240V, 200W, 0.8 Amps	2 3/8"H x 18"W x 24"L	27	\$860.00
21670536	WS-3	36" surface	120V, 300W, 2.5 Amps	2 3/8"H x 18"W x 36"L	38	\$1,019.00
21671036	WS-3	36" surface	208V, 300W, 1.4 Amps	2 3/8"H x 18"W x 36"L	38	\$1,019.00
21671136	WS-3	36" surface	240V, 300W, 6.2 Amps	2 3/8"H x 18"W x 36"L	38	\$1,019.00
21670548	WS-4	48" surface	120V, 400W, 3.3 Amps	2 3/8"H x 18"W x 48"L	49	\$1,185.00
21671048	WS-4	48" surface	208V, 400W, 1.9 Amps	2 3/8"H x 18"W x 48"L	49	\$1,185.00
21671148	WS-4	48" surface	240V, 400W, 1.7 Amps	2 3/8"H x 18"W x 48"L	49	\$1,185.00
21670560	WS-5	60" surface	120V, 500W, 4.2 Amps	2 3/8"H x 18"W x 60"L	56	\$1,290.00
21671060	WS-5	60" surface	208V, 500W, 2.4 Amps	2 3/8"H x 18"W x 60"L	56	\$1,290.00
21671160	WS-5	60" surface	240V, 500W, 2.1 Amps	2 3/8"H x 18"W x 60"L	56	\$1,290.00
21670572	WS-6	72" surface	120V, 600W, 5.0 Amps	2 3/8"H x 18"W x 72"L	70	\$1,474.00
21671072	WS-6	72" surface	208V, 600W, 2.9 Amps	2 3/8"H x 18"W x 72"L	70	\$1,474.00
21671172	WS-6	72" surface	240V, 600W, 2.5 Amps	2 3/8"H x 18"W x 72"L	70	\$1,474.00
Export Models						
21670924	WS-2	24" surface	230V, 200W, .9 Amps	2 3/8"H x 18"W x 24"L	27	\$908.00
21670936	WS-3	36" surface	230V, 300W, 1.3 Amps	2 3/8"H x 18"W x 36"L	38	\$1,067.00
21670948	WS-4	48" surface	230V, 400W, 1.8 Amps	2 3/8"H x 18"W x 48"L	49	\$1,249.00
21670960	WS-5	60" surface	230V, 500W, 2.2 Amps	2 3/8"H x 18"W x 60"L	56	\$1,406.00
21670972	WS-6	72" surface	230V, 600W, 2.7 Amps	2 3/8"H x 18"W x 72"L	70	\$1,566.00

X*PERT[™] Roller Grill SERIES

X*PERT[™] Series Roller Grills

As a premier manufacturer of roller grill systems, APW Wyatt provides a wide range of grills well suited to almost any merchandising requirement. Our attractive Roller Grills feature easy-to-use electrical controls, convenient integrated holding drawers and a number of additional features that enable retailers to create the ideal solution for their specific roller grill need.

X*PERT[™] Series Flat HotRod[®] Roller Grills

The Hotrod[®] Roller Grills are available with chrome or "Tru-Turn" non-stick rollers. Fully adjustable infinite controls and Polytetrafluoroethylene grease seals to keep mechanism clean. The HR(S)-20 can grill up to 340 franks, the HR(S)-31 can grill up to 510 franks and the HR(S)-50 can grill up to 850 franks per hour. Note: 7/16" space between rollers. If shipping via air freight, dimensional weights apply. Backed by APW's One Year Warranty. FOB Standex Dock, freight class 70.



Part Number	Model	Electric	Dimensions	Weight (lbs)	Price
Flat Chrome Surface Rollers					
21836025	HR-20	120V, 768W, 6.4 Amps	9 1/8"H x 17 1/4"W x 18 5/8"D	35	\$1,980.00
21834230	HR-31	120V, 985W, 8.3 Amps	9 1/8"H x 23 3/4"W x 18 5/8"D	42	\$2,079.00
21834330	HR-31	208/240V, 885/1160W, 3.2/4.8 Amps	9 1/8"H x 23 3/4"W x 18 5/8"D	42	\$2,079.00
21831745	HR-45	120V, 1465W, 12.2 Amps	9 1/8"H x 23 3/4"W x 29 9/16"D	46	\$2,699.00
21836055	HR-50	120V, 1320W, 11 Amps	9 1/8"H x 34 3/4"W x 18 5/8"D	55	\$2,279.00
21836255	HR-50	208/240V, 1265/1665W, 6.2/7 Amps	9 1/8"H x 34 3/4"W x 18 5/8"D	55	\$2,279.00
21831875	HR-75 **	120V, 985W, 8.3/10.1 Amps	9 1/8"H x 34 3/4"W x 29 9/16"D	87	\$3,329.00
21831775	HR-75	208/240V, 1820/2410W, 8.9/10.1 Amps	9 1/8"H x 34 3/4"W x 29 9/16"D	110	\$3,329.00
21838885	HR-85	208/240V, 2017/2640W, 9.7/11.0 Amps	9 1/8"H x 34 3/4"W x 29 9/16"D	110	\$3,614.00
Tru-Turn Surface Rollers					
21833320	HRS-20	120V, 768W, 6.4 Amps	9 1/8"H x 17 1/4"W x 18 5/8"D	35	\$2,051.00
21834231	HRS-31	120V, 985W, 8.3 Amps	9 1/8"H x 23 3/4"W x 18 5/8"D	42	\$2,221.00
21834331	HRS-31	208/240V, 885/1160W, 3.2/4.8 Amps	9 1/8"H x 23 3/4"W x 18 5/8"D	42	\$2,221.00
21831645	HRS-45	120V, 1465W, 12.2 Amps	9 1/8"H x 23 3/4"W x 29 9/16"D	66	\$3,152.00
21833350	HRS-50	120V, 1320W, 11 Amps	9 1/8"H x 34 3/4"W x 18 5/8"D	55	\$2,625.00
21833450	HRS-50	208/240V, 1265/1665W, 6.2/7 Amps	9 1/8"H x 34 3/4"W x 18 5/8"D	55	\$2,625.00
21833375	HRS-75 **	120V, 985W, 8.3/10.1 Amps	9 1/8"H x 34 3/4"W x 29 9/16"D	87	\$4,114.00
21831675	HRS-75	208/240V, 1820/2410W, 8.9/10.1 Amps	9 1/8"H x 34 3/4"W x 29 9/16"D	110	\$4,114.00
21833485	HRS-85	208/240V, 2017/2640W, 9.7/11.0 Amps	9 1/8"H x 34 3/4"W x 29 9/16"D	110	\$4,760.00

**Not CUL Approved (2 power cords), 60hz, 1 phase

X*PERT[™] Series Slanted HotRod[®] Roller Grills

Great Merchandising grill that builds product appetite appeal by facing products toward the customer. The Slanted Hotrod[®] Roller Grills come in chrome or "TRU-turn" non-stick rollers. The HR(S)-20S can grill up to 306 franks, the HR(S)-31S can grill up to 460 franks and the HR(S)-50S can grill up to 765 franks per hour. If shipping via air freight, dimensional weights apply. Backed by APW's One Year Warranty. FOB Standex Dock, freight class 70.

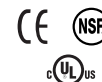

Part Number	Model	Electric	Dimensions	Weight (lbs)	Price
Flat Chrome Surface Rollers					
21831820	HR-20S	120V, 703W, 5.9 Amps	11 3/4"H x 17 1/4"W x 18 5/8"D	35	\$1,980.00
21831830	HR-31S	120V, 900W, 7.6 Amps	11 3/4"H x 23 3/4"W x 18 5/8"D	42	\$2,079.00
21832430	HR-31S	208/240V, 885/1160W, 3.2/4.8 Amps	11 3/4"H x 23 3/4"W x 18 5/8"D	42	\$2,079.00
21831850	HR-50S	120V, 1320W, 11 Amps	11 3/4"H x 34 3/4"W x 18 5/8"D	55	\$2,279.00
21832450	HR-50S	208/240V, 1260/1665W, 6.7/7 Amps	11 3/4"H x 34 3/4"W x 18 5/8"D	55	\$2,279.00
Tru-Turn Surface Rollers					
21831920	HRS-20S	120V, 703W, 5.9 Amps	11 3/4"H x 17 1/4"W x 18 5/8"D	35	\$2,051.00
21831930	HRS-31S	120V, 900W, 7.6 Amps	11 3/4"H x 23 3/4"W x 18 5/8"D	42	\$2,221.00
21832530	HRS-31S	208/240V, 885/1160W, 3.2/4.8 Amps	11 3/4"H x 23 3/4"W x 18 5/8"D	42	\$2,221.00
21831950	HRS-50S	120V, 1320W, 11 Amps	11 3/4"H x 34 3/4"W x 18 5/8"D	55	\$2,625.00
21832550	HRS-50S	208/240V, 1260/1665W, 6.7/7 Amps	11 3/4"H x 34 3/4"W x 18 5/8"D	55	\$2,625.00

X*PERT[™] Roller Grill

SERIES

CE and Export Models

The same detail-oriented design and craftsmanship that go into our domestic roller grills can be found in our export models as well. The CE and Export Roller Grills are available with either chrome or "TRU-TURN" non-stick rollers. Simple to use controls and easy-clean surfaces make these roller grills ideal for merchandising and self-serve applications.

Backed by APW's One Year Warranty. FOB Standex Dock, freight class 70.



Part Number	Model	Electric	Dimensions	Weight (lbs)	Price
Flat Chrome Surface Rollers					
21833631	HR-31	230V, 990W, 4.5 Amps	8 1/2"H x 23 3/4"W x 18 5/8"D	42	\$2,079.00
21836255	HR-50	208/240V, 1260/1665W, 6.2/7.0 Amps	8 1/2"H x 34 3/4"W x 18 5/8"D	55	\$2,279.00
21835375	HR-75	230V, 1665W, 50 Hz	8 1/2"H x 34 3/4"W x 29 9/16"D	110	\$3,436.00
Slanted Chrome Surface Rollers					
21832430	HR-31S	208/240V, 905W, 4 Amps	11 3/4"H x 23 3/4"W x 18 5/8"D	42	\$2,079.00
21832450	HR-50S	208/240V, 1260/1665W, 6.2/7.0 Amps	11 3/4"H x 34 3/4"W x 18 5/8"D	55	\$2,279.00
Flat Tru-Turn Surface Rollers					
21837331	HRS-31	230V, 895W, 4.3 Amps	8 1/2"H x 23 3/4"W x 18 5/8"D	42	\$2,221.00
21837350	HRS-50	230V, 1260W, 6.2 Amps	8 1/2"H x 34 3/4"W x 18 5/8"D	55	\$2,625.00
21831680	HRS-75	208V, 1260W, 10.2 Amps	8 1/2"H x 34 3/4"W x 29 9/16"D	110	\$4,113.00
Slanted Tru-Turn Surface Rollers					
21832530	HRS-31S	208/240V, 895/1152W, 4.3/4.8 Amps	11 3/4"H x 23 3/4"W x 18 5/8"D	42	\$2,221.00
21832550	HRS-50S	208/240V, 1260/1665W, 6.2/7.0 Amps	11 3/4"H x 34 3/4"W x 18 5/8"D	55	\$2,625.00

X*PERT[™] Series HR-BC "All-in-One" HotRod[®] Roller Grill Systems

The X*PERT[™] Series HR-BC Roller Grills feature Built-in Bun Cabinets with clear lift up plexiglass doors for product visibility and easy accessibility. Available with chrome or "Tru-Turn" non-stick rollers, fully adjustable infinite controls and Polytetrafluoroethylene grease seals to keep mechanism clean. Backed by APW's One Year Warranty. FOB Standex Dock, freight class 70.



Part Number	Model	Electric	Dimensions	Weight (lbs)	Price
Flat Chrome Surface Rollers					
21838431	HR-31BC	120V, 996W, 8.3 Amps	13 3/8"H x 23 3/4"W x 18 5/8"D	42	\$2,438.00
21838450	HR-50BC	120V, 1320W, 11 Amps	13 3/8"H x 34 3/4"W x 18 5/8"D	55	\$2,651.00
Slanted Chrome Surface Rollers					
21838531	HR-31SBC	120V, 985W, 8.3 Amps	16 1/8"H x 23 3/4"W x 18 5/8"D	42	\$2,438.00
21838550	HR-50SBC	120V, 1320W, 11 Amps	16 1/8"H x 34 3/4"W x 18 5/8"D	55	\$2,651.00
Flat Tru-Turn Surface Rollers					
21837631	HRS-31BC	120V, 985W, 8.3 Amps	13 3/8"H x 23 3/4"W x 18 5/8"D	42	\$2,581.00
21837650	HRS-50BC	120V, 1320W, 11 Amps	13 3/8"H x 34 3/4"W x 18 5/8"D	55	\$3,010.00
Slanted Tru-Turn Surface Rollers					
21837731	HRS-31SBC	120V, 985W, 8.3 Amps	16 1/8"H x 23 3/4"W x 18 5/8"D	42	\$2,581.00
21837750	HRS-50SBC	120V, 1320W, 11 Amps	16 1/8"H x 34 3/4"W x 18 5/8"D	55	\$3,010.00

X*PERT™ Roller Grill SERIES

X*PERT™ Series HR-BD "All-in-One" HotRod® Roller Grill Systems

The X*PERT™ Series HR-BD Roller Grills feature Built-in Bun Drawers for storage of un-heated buns and easy accessibility. Available with chrome or "Tru-Turn" non-stick rollers, fully adjustable infinite controls and Polytetrafluoroethylene grease seals to keep mechanism clean. Backed by APW's One Year Warranty. FOB Standex Dock, freight class 70.

Part Number	Model	Electric	Dimensions	Weight (lbs)	Price
Flat Chrome Surface Rollers					
21838631	HR-31BD	120V, 985W, 8.3 Amps	13 3/8"H x 23 3/4"W x 18 5/8"D	42	\$3,010.00
21838650	HR-50BD	120V, 1320W, 11 Amps	13 3/8"H x 34 3/4"W x 18 5/8"D	55	\$3,298.00
Slanted Chrome Surface Rollers					
21838531	HR-31SBD	120V, 985W, 8.3 Amps	16 1/8"H x 23 3/4"W x 18 5/8"D	42	\$3,010.00
21838550	HR-50SBD	120V, 1320W, 11 Amps	16 1/8"H x 34 3/4"W x 18 5/8"D	55	\$3,298.00
Flat Tru-Turn Surface Rollers					
21836831	HRS-31BD	120V, 985W, 8.3 Amps	13 3/8"H x 23 3/4"W x 18 5/8"D	42	\$3,226.00
21836850	HRS-50BD	120V, 1320W, 11 Amps	13 3/8"H x 34 3/4"W x 18 5/8"D	55	\$3,757.00
Slanted Tru-Turn Surface Rollers					
21837531	HRS-31SBD	120V, 985W, 8.3 Amps	16 1/8"H x 23 3/4"W x 18 5/8"D	42	\$3,226.00
21837550	HRS-50SBD	120V, 1320W, 11 Amps	16 1/8"H x 34 3/4"W x 18 5/8"D	55	\$3,757.00

X*PERT™ Series HR-BW "All-in-One" HotRod® Roller Grill Systems

The X*PERT™ Series HR-BW Roller Grills feature Built-in Bun Warmers that are heated and thermostatically controlled. Available with chrome or "Tru-Turn" non-stick rollers, fully adjustable infinite controls and Polytetrafluoroethylene grease seals to keep mechanism clean. Backed by APW's One Year Warranty. FOB Standex Dock, freight class 70.

Part Number	Model	Electric	Dimensions	Weight (lbs)	Price
Flat Chrome Surface Rollers					
21839031	HR-31BW	120V, 985W, 8.3 Amps	13 3/8"H x 23 3/4"W x 18 5/8"D	42	\$3,699.00
21839050	HR-50BW	120V, 1320W, 11 Amps	13 3/8"H x 34 3/4"W x 18 5/8"D	55	\$4,267.00
Slanted Chrome Surface Rollers					
21838931	HR-31SBW	120V, 985W, 8.3 Amps	16 1/8"H x 23 3/4"W x 18 5/8"D	42	\$3,699.00
21838950	HR-50SBW	120V, 1320W, 11 Amps	16 1/8"H x 34 3/4"W x 18 5/8"D	55	\$4,186.00
Flat Tru-Turn Surface Rollers					
21838131	HRS-31BW	120V, 985W, 8.3 Amps	13 3/8"H x 23 3/4"W x 18 5/8"D	42	\$3,851.00
21838150	HRS-50BW	120V, 1320W, 11 Amps	13 3/8"H x 34 3/4"W x 18 5/8"D	55	\$4,488.00
Slanted Tru-Turn Surface Rollers					
21838231	HRS-31SBW	120V, 985W, 8.3 Amps	16 1/8"H x 23 3/4"W x 18 5/8"D	42	\$3,851.00
21838250	HRS-50SBW	120V, 1320W, 11 Amps	16 1/8"H x 34 3/4"W x 18 5/8"D	55	\$4,488.00

X*PERT™ Series Digital Roller Grills

Great Merchandising grill that builds product appetite appeal by facing products toward the customer. The X*PERT™ Series Digital Hotrod® Roller Grills come with "TRU-turn" non-stick rollers. The HRDi-31S can grill up to 460 franks and the HRDi-50S can grill up to 765 franks per hour. The New Digital Roller Grill utilizes the latest control technology to improve performance. It will improve your overall operations by minimizing waste and reducing labor all while adhering to HACCP food safety standards. If shipping via air freight, dimensional weights apply. Backed by APW's One Year Warranty. FOB Standex dock, freight class 70.



Part Number	Model	Electric	Dimensions	Weight (lbs)	Price
Flat Tru-Turn Surface Rollers					
21877030	HRSDi-31	120V, 984W, 8.2 Amps	8 1/2"H x 23 3/4"W x 18 5/8"D	44	\$2,584.00
21877032	HRSDi-31	208/240V, 1172/1560W, 8.2 Amps	8 1/2"H x 23 3/4"W x 18 5/8"D	44	\$2,584.00
21877050	HRSDi-50	120V, 1424W, 11.9 Amps	8 1/2"H x 34 3/4"W x 18 5/8"D	55	\$3,015.00
21877052	HRSDi-50	208/240V, 1270/1691W, 6.1/7.1 Amps	8 1/2"H x 34 3/4"W x 18 5/8"D	55	\$3,015.00
Slanted Tru-Turn Surface Rollers					
21877130	HRSDi-31S	120V, 984W, 8.2 Amps	11 3/4"Hx23 3/4"Wx18 5/8"D	44	\$2,584.00
21877132	HRSDi-31S	208/240V, 1172/1560W, 8.2 Amps	11 3/4"Hx23 3/4"Wx18 5/8"D	44	\$2,584.00
21877150	HRSDi-50S	120V, 1424W, 11.9 Amps	11 3/4"Hx34 3/4"Wx18 5/8"D	55	\$3,015.00
21877152	HRSDi-50S	208/240V, 1270/1691W, 6.1/7.1 Amps	11 3/4"Hx34 3/4"Wx18 5/8"D	55	\$3,015.00

X*PERT[™] Roller Grill

SERIES

Sneeze Guards

Molded self-serve Sneeze Guards provide food safety at the same time maintaining clear visibility to the hot dogs, building appetite appeal with customers. Sneeze guards also maintain heat within roller area. Options include single door access or dual door versions. If shipping via air freight, dimensional weights apply. FOB Standex Dock, freight class 250.



Part Number	Model	Dimensions	Weight (lbs)	Price
Single Door Sneeze Guards				
21751020	SG-20	9"H x 18 7/8"W x 19 1/2"D	5	\$406.00
21771530	SG-31	9"H x 24 1/4"W x 19 1/2"D	6	\$464.00
21751050	SG-50	9"H x 35 1/2"W x 19 1/2"D	9	\$600.00
Contact CS	SG-75/85	9"H x 35 1/2"W x 30 21/32"D	15	\$700.00
21809770	SG-75W	One Door	15	\$867.00
Dual Door Sneeze Guard				
21771550	SG-45DD	9"H x 24 1/2"W x 30 21/32"D	10	\$1,109.00
Pass Through Canopy Style Sneeze Guards with Metal Frame				
21772931	SG-31XP	8"H x 26 1/2"W x 19 13/64"D	10	\$530.00
30060080	SG-50XP	8"H x 37 1/2"W x 19 13/64"D	13	\$660.00
30059900	SG-75/85XP	8"H x 37 1/2"W x 30 1/2"D	17	\$808.00
Pass Through Canopy Style Sneeze Guards with Metal Frames and Enclosed Sides				
21773931	SG-31XPC	8"H x 26 1/2"W x 19 13/64"D	12	\$681.00
21773950	SG-50XPC	8"H x 37 1/2"W x 19 13/64"D	12	\$856.00
21773995	SG-75XPC	8"H x 37 1/2"W x 30 1/2"D	20	\$1,052.00
Replacement Doors				
21805420	SG-20	Replacement Door for SG-20	1	\$90.00
21805430	SG-31	Replacement Door for SG-31	1	\$90.00
21805450	SG-50	Replacement Door for SG-50	1	\$90.00

Options for HotRod[®] Roller Grills

Expand the versatility and merchandising capabilities of Hotrod[®] roller grills with certified APW accessories and options.

Part Number	Description	Price
4939100	4" Metal Leg Kit	\$157.00
3029200	6" Plastic Tongs	\$27.00
21792800	9" Plastic Tongs & Tong Holder	\$61.00
21783930	Front cover & decal for control (HR-31 & HRS-31)	\$150.00
21783950	Front cover & decal for control (HR-50 & HRS-50)	\$87.00
21794060	HR-20 Kit Divider	\$102.00
21794061	HR-20 Slant Kit Divider	\$269.00
21794062	HR-31 Kit Divider	\$110.00
21794063	HR-31 Slant Kit Divider	\$103.00
21794064	HR-45 Kit Divider	\$111.00
21794065	HR-50 Kit Divider	\$137.00
21794066	HR-50 Slant Kit Divider	\$137.00
21794067	HR-75/85 Kit Divider	\$150.00

Concession

SERIES

Concession Equipment

Whether keeping grilled foods warm, buns fresh and moist or condiments cool, APW Wyott's comprehensive line of concession equipment is designed for safe food handling, simplicity of use and durable, long-lasting performance. Easy-to-clean stainless steel surfaces, simple, intuitive controls and attention-grabbing merchandising graphics make these products ideal for any retail operation.

X*PERT™ Series SPTU Thermo-Drawer

The new and improved SPTU Thermo-Drawer features; Easy to use controls; Larger, deeper drawer design; Removal drawer for easy cleaning; Slim-line design; Patent pending innovative heating system; Hold Product for up to 6 Hours. The X*PERT™ Series Thermo-drawer is the perfect complement to your roller grill. It will improve customer satisfaction with hot, fresh, quality food in a timely fashion. It will improve your overall operations by minimizing waste and reducing labor all while adhering to HACCP food safety standards. Backed by APW's One Year Warranty. FOB Standex Dock, freight class 100.



Part Number	Model	Electric	Dimensions	Weight (lbs)	Price
25000130	SPTU-30	120V, 4.125 Amps	4 3/4"H x 23 3/4"W x 19 1/4"D	55	\$1,513.00
25000131	SPTU-30	208/240V, 2.1/2.4 Amps	4 3/4"H x 23 3/4"W x 19 1/4"D	55	\$1,513.00
25000030	SPTU-30N	120V, 3 Amps	4 3/4"H x 19 1/4"W x 19 1/4"D	55	\$1,513.00
25000031	SPTU-30N	208/240V, 1.6/1.8 Amps	4 3/4"H x 19 1/4"W x 19 1/4"D	55	\$1,513.00
25000150	SPTU-50	120V, 5.8 Amps	4 3/4"H x 34 3/4"W x 19 1/4"D	80	\$1,671.00
25000151	SPTU-50	208/240V, 3/3.5 Amps	4 3/4"H x 34 3/4"W x 19 1/4"D	80	\$1,671.00
25000067	SPTU-50N	120V, 5.8 Amps	4 3/4"H x 30 1/4"W x 19 1/4"D	80	\$1,671.00
25000051	SPTU-50N	208/240V, 3/3.5 Amps	4 3/4"H x 30 1/4"W x 19 1/4"D	80	\$1,671.00
Options					
25000109	SPTU-30	Divider Kit			\$291.00
25000110	SPTU-50	Divider Kit			\$507.00

Bun Cabinets

Bun Cabinets conveniently hold un-heated buns under the roller grill in easy reach of customers or clerk. The standard cabinet features stainless steel body with clear lift up plexiglass doors, for product visibility and easy accessibility. Drawer model is a full stainless steel unit with sliding door. If shipping via air freight, dimensional weights apply. Backed by APW's One Year Warranty. FOB Standex Dock, freight class 85.



Part Number	Model	Description	Dimensions	Weight (lbs)	Price
21751500	BC-20	50 bun capacity	6 3/8"H x 17 3/16"W x 18 5/8"D	16	\$423.00
21773800	BC-31	100 bun capacity	6 3/8"H x 23 11/16"W x 18 5/8"D	22	\$472.00
21749800	BC-50	144 bun capacity	6 3/8"H x 34 11/16"W x 18 5/8"D	29	\$546.00
Bun Cabinet with Drawer					
21773700	BC-31D	100 bun capacity	6 3/8"H x 22 11/16"W x 18 5/8"D	26	\$745.00
21750850	BC-50D	144 bun capacity	6 3/8"H x 34 11/16"W x 18 5/8"D	40	\$961.00

Bun Warmers

The Bun Warmers provide gentle warmth for buns, keeping them an ideal temperature and texture for the perfect hot dog. The BW-20, -31 and -50's are drawer-type Bun Warmers. Drawer type versions have a stainless steel bun pan that has sliding lid and infinite temperature control for optimal warmth. If shipping via air freight, dimensional weights apply. Backed by APW's One Year Warranty. FOB Standex Dock, freight class 100.



Part Number	Model	Description	Electric	Dimensions	Weight (lbs)	Price
21741020	BW-20	36 bun cap.	120V, 500W, 4.2 Amps	10 5/8"H x 17 3/4"W x 22 1/8"D	49	\$1,515.00
21772800	BW-31	72 bun cap.	120V, 400W, 3.3 Amps	10 5/8"H x 23 3/4"W x 22 1/8"D	60	\$1,838.00
21775250	BW-50	100 bun cap.	120V, 600W, 5 Amps	10 5/8"H x 34 3/4"W x 22 1/8"D	86	\$2,241.00
CE + Export Models						
21741104	BW-31	72 bun cap.	220V, 400W, 1.8 Amps	10 5/8"H x 23 3/4"W x 22 1/8"D	60	\$1,927.00
21741250	BW-50	100 bun cap.	220V, 600W, 2.7 Amps	10 5/8"H x 34 3/4"W x 22 1/8"D	86	\$2,350.00

Concession SERIES

Bun Warmers, Dry

The Bun Warmer Dry (Heated) is designed to complement our best selling Hot Dog Roller Grill Products and provide gentle warmth for buns, keeping them an ideal temperature and texture for the perfect hot dog. Available in a variety of sizes to fit your counter space: BWD-31 and BWD-50 (Use with HR(S)-31(S)- 50(S) Roller Grills); BWD-45 and BWD-75 with spacer (Use with HR(S)-45(S)-75(S) Roller Grills); BWD-75N (Use to fit between legs of HR(S)-75(S) Roller Grills with 6" Legs). Backed by APW's One Year Warranty. FOB Standex Dock, freight class 100.



Part Number	Model	Description	Electric	Dimensions	Weight (lbs)	Price
21858900	BWD-31	24 bun capacity	120v, 200w, 1.7 Amps	6"H x 23 3/4"W x 19 9/16"D	65	\$805.00
21859000	BWD-31	24 bun capacity	208v, 200w, 1.1 Amps	6"H x 23 3/4"W x 19 9/16"D	65	\$805.00
21858300	BWD-45	24 bun capacity	120v, 200w, 1.7 Amps	6"H x 23 3/4"W x 30 1/2"D	68	\$906.00
21858200	BWD-45	24 bun capacity	208v, 200w, 1.1 Amps	6"H x 23 3/4"W x 30 1/2"D	68	\$906.00
21858700	BWD-50	40 bun capacity	120v, 200w, 1.7 Amps	6"H x 34 3/4"W x 19 9/16"D	91	\$888.00
21858800	BWD-50	40 bun capacity	208/240v, 200/265w, 1.1 Amps	6"H x 34 3/4"W x 19 9/16"D	91	\$888.00
21858500	BWD-75N	32 bun capacity	208/240v, 200/265w, 1.1 Amps	6"H x 31 3/4"W x 19 9/16"D	98	\$915.00
21858600	BWD-75	40 bun capacity	208v, 200w, 1.1 Amps	6"H x 34 3/4"W x 19-9/16"D	98	\$887.00

New Side Bun Warmer

The New Side Bun Warmer Dry (Heated) is designed to complement our best selling Hot Dog Roller Grill Products and provide gentle warmth for buns (100°-120°F), keeping them an ideal temperature and texture for the perfect hot dog. Symmetrical design allows the unit to be mounted on either side of the roller grill. Magnets allow user to move unit from right to left of roller grill. Backed by APW's One Year Warranty. FOB Standex Dock, freight class 100.



Part Number	Model	Electric	Dimensions	Weight (lbs)	Price
21857900	SBW-120	120v, 200W, 60HZ	7 3/4"H x 3.5"W x 19"D	10	\$419.00

Mr. Frank Hot Dog Steamers

Hot Dogs are safely cooked, buns are gently warmed...and merchandised to your customers. Steam is generated from a non-exposed heating source, making this unit the easiest to clean in the industry. Special angled shield at the top of the interior directs condensation from steam away from the hot dog buns. Stainless steel and tempered glass construction. The DS-1A holds over 150 hot dogs and over 60 buns. If shipping via air freight, dimensional weights apply. Backed by APW's One Year Warranty. FOB Standex Dock, freight class 100.



Part Number	Model	Electric	Dimensions	Weight (lbs)	Price
44664000	DS-1A	120V, 800W, 6.7 Amps	20 1/2"H x 16"W x 14"D	36	\$1,045.00
44664010	DS-1AP (2 door self serve unit)	120V, 800W, 6.7 Amps	20 1/2"H x 16"W x 14"D	40	\$1,153.00
CE + Export Models					
98416000	DS-1A	230V, 50Hz, 735W, 3.2 Amps	20 1/2"H x 16"W x 14"D	36	\$1,045.00
21719200	DS-1AP	230V, 735W, 3.2 Amps	20 1/2"H x 16"W x 14"D	40	\$1,153.00

Refrigerated Topping Rails

Refrigerated countertop system that keep everything at NSF safe temperatures. The RTR-8 holds eight 1/6th size pans, the upper section holds 4 6" deep pans and the lower section holds four 4" deep pans. The RTR-4 holds 4 pans 1/6th size, 6" deep pans. Each pan has its own hinged, removable cover. All stainless steel construction and 1/2" nonadjustable legs. Cold wall refrigeration system utilizing a 1/5 hp compressor. If shipping via air freight, dimensional weights apply. Backed by APW's One Year Warranty. FOB Standex Dock, freight class 70.



Part Number	Model	Electric	Dimensions	Weight (lbs)	Price	
21876000	RTR-4	120V, 360W, 60 Hz, 1 Ph, 3 Amps	17"W x 25 5/16"D x 11 7/16"H	78	\$2,304.00	
31701012	RTR-8	120V, 480W, 60 Hz, 1 Ph, 4 Amps	27 1/2"W x 25 13/16"D x 8 1/2"H	108	\$4,108.00	
Export Models						
30052100	RTR-4	230V, 460W, 50 Hz, 1 Ph, 2 Amps	17"W x 25 5/16"D x 11 7/16"H	78	\$2,304.00	
31701022	RTR-8	220V, 462W, 50 Hz, 1 Ph, 2.1 Amps	27 1/2"W x 25 13/16"D x 8 1/2"H	108	\$4,108.00	
Options						
1800100	COMP-5	5-year Compressor Warranty (Net Price)				\$224.00
4939100		4" Metal Leg Kit			2	\$157.00
21807560		12" Bar			2	\$16.00
21807565		20" Bar			2	\$38.00

Concession SERIES

Countertop Cold Wells

Countertop Cold Wells are portable and provide an economic solution that eliminates the cost of in-counter refrigeration. Designed to hold cold foods at 34°F - 40°F. Stainless steel construction with fully insulated walls using R134A refrigerant. Hinged cover included. Holds standard steam table pans. Cannot ship UPS. If shipping via air freight, dimensional weights apply. Backed by APW's One Year Warranty. FOB Standex Dock, freight class 70.



Part Number	Model	Description	Electric	Dimensions	Weight (lbs)	Price	
30048400	CTCW-43	4/3 size 12x27	120V, 1/6 hp, 3 Amps	18 1/2" H (w/lid) x 15"W x 29 9/16"D	90	\$4,024.00	
Options							
1800100	COMP-5	5-year Compressor Warranty (Net Price)					\$224.00

Drop-In Refrigerated Topping Rails

Flush mount refrigerated countertop system that keep everything at NSF safe temperatures. The RTR-4Di holds four 1/6th size pans, 6" deep. Each pan has its own hinged, removable cover. All stainless steel construction. Cold wall refrigeration system utilizing a 1/6 hp compressor. If shipping via air freight, dimensional weights apply. Backed by APW's One Year Warranty. FOB Standex Dock, freight class 70.



Part Number	Model	Electric	Dimensions	Weight (lbs)	Price
30060600	RTR-4Di	120V, 360W, 60 Hz, 1 Ph, 3 Amps	16 13/32"W x 17 13/32"D x 18 3/4"H	67	\$2,304.00

Heated Display Cabinets

Great way to merchandise Pizza without drying out product. Stainless steel construction, large tempered glass windows, 1" adjustable legs and reversible hinged door. Features revolving display rack that stops when door is opened. Four shelves accommodating 18" diameter pans. Handles crispy or moist food equally well, with air convection heater (dry) and humidity water heater (moist). Model comes standard with pizza rack & pizza decal. If shipping via air freight, dimensional weights apply. Backed by APW's One Year Warranty. FOB Standex Dock, freight class 100.



Part Number	Model	Electric	Dimensions	Weight (lbs)	Price
30055500	HDC-4	120V, 1300W, 11.5 Amps	29"H x 22 3/16"W x 22 3/16"D	105	\$4,013.00
30055600	HDC-4P (pass thru)	120V, 1300W, 11.5 Amps	29"H x 22 3/16"W x 22 3/16"D	105	\$4,423.00
Export Models					
30055522	HDC-4	220V, 1430W, 7.0 Amps	29"H x 22 3/16"W x 22 3/16"D	105	\$4,013.00
30055622	HDC-4P (pass thru)	220V, 1430W, 7.0 Amps	29"H x 22 3/16"W x 22 3/16"D	105	\$4,423.00
Options					
21721546		Pretzel Display Rack			\$395.00
21721548		4 Shelf Food Flat Rack	19"H x 19"W x 18 3/4"D		\$422.00
21765300		Pizza Merchandising Decal			\$72.00
21769100		Pretzel Merchandising Decal			\$72.00

Heated Display Warming Cabinet

Keeps a variety of packaged foods at a safe holding temperature above 150 degrees, and provides fast, easy accessibility to the consumer. Clear front and sides, combined with slanted shelves provide total visibility. Dome light illuminates the product while attractive domed cover draws attention and can easily be merchandised with add-on "food decals". Front and back doors allow the customer to "self-serve" from the front and the clerk to load from behind. Stainless steel insides wipe clean with damp cloth. Lightweight unit facilitates easy movement. Backed by APW's One Year Warranty. FOB Standex Dock, freight class 100.



Part Number	Model	Description	Electric	Dimensions	Weight (lbs)	Price
30057000	DWCI-14	Single Door	120V, 208W, 2.0 Amps	22"H x 14"W x 14"D	32	\$973.00
30057010	DWCI-14	Pass Through	120V, 208W, 2.0 Amps	22"H x 14"W x 14"D	32	\$973.00

Merchandiser

SERIES

Merchandising Made Easy

Presentation can make the difference between profit and loss. APW Wyott® Food Merchandising displays make the difference between average presentation and attention-grabbing, sales-generating, "buy it now, eat it fast and come back for more" food presentation. Designed for maximum visibility and easy of use, these display products set the standard for retail food merchandising.

Racer® Countertop Display Merchandisers

New, great looking display merchandiser that keeps a variety of packaged foods hot, and provides fast and easy accessibility to the consumer. Available in one or two shelf versions, either in a flat shelf or slanted design. Racer® Merchandisers keep wrapped product at NSF safe temperatures through a system of infrared overhead heat and a thermostatically controlled heated base. The Racer® line is the most durable and sturdy merchandiser on the market. The infrastructure and support is made of solid stainless steel. Unit will not sway from side to side or sag in the middle. Heated base is designed with special coated aluminum that transfers heat efficiently, plus allows boxes and wrapped products to smoothly slide down toward the front. Tempered glass end panels allow maximum visibility, while shatter resistant incandescent lights builds the overall presentation. If shipping via air freight, dimensional weights apply. Backed by APW's One Year Warranty. FOB Standex Dock, freight class 100.



DMXS-30H Horizontal



DMXD-30S Slanted



Colors must be ordered at time of order entry.

STANDARD COLORS

Front Channel Holder Black
 Front Channel Red
 Side Support Red

Part Number	Model	Electric	Dimensions	Weight (lbs)	Price
Racer® Horizontal Display Merchandiser - Single Shelf					
23050010	DMXS-30H	120V, 715W, 6.0 Amps	18"H x 30"W x 27 1/4"D	121	\$3,016.00
23650010	DMXS-36H	120V, 865W, 7.2 Amps	18"H x 36"W x 27 1/4"D	161	\$3,245.00
24250010	DMXS-42H	120V, 1015W, 8.5 Amps	18"H x 42"W x 27 1/4"D	179	\$3,712.00
24850010	DMXS-48H	120V, 1260W, 10.5 Amps	18"H x 48"W x 27 1/4"D	198	\$3,929.00
25450010	DMXS-54H	120V, 1400W, 11.7 Amps	18"H x 54"W x 27 1/4"D	208	\$4,459.00
26050010	DMXS-60H	120V, 1560W, 13.0 Amps	18"H x 60"W x 27 1/4"D	226	\$4,828.00
Racer® Horizontal Display Merchandiser - Double Shelf					
23050030	DMXD-30H	120V, 1380W, 11.5 Amps	27 1/2"H x 30"W x 27 1/4"D	176	\$5,055.00
23650030	DMXD-36H	120V, 1680W, 14.0 Amps	27 1/2"H x 36"W x 27 1/4"D	215	\$5,351.00
24250030	DMXD-42H	120V, 1965W, 16.4 Amps	27 1/2"H x 42"W x 27 1/4"D	235	\$5,851.00
24850031	DMXD-48H	208V, 2470W, 10.3 Amps	27 1/2"H x 48"W x 27 1/4"D	260	\$6,181.00
25450031	DMXD-54H	208V, 2725W, 11.4 Amps	27 1/2"H x 54"W x 27 1/4"D	270	\$6,970.00
26050031	DMXD-60H	208V, 3045W, 12.7 Amps	27 1/2"H x 60"W x 27 1/4"D	280	\$7,542.00
Racer® Slanted Display Merchandiser - Single Shelf					
23050020	DMXS-30S	120V, 715W, 6.0 Amps	23"H x 30"W x 27"D	150	\$3,362.00
23650020	DMXS-36S	120V, 865W, 7.2 Amps	23"H x 36"W x 27"D	161	\$3,564.00
24250020	DMXS-42S	120V, 1015W, 8.5 Amps	23"H x 42"W x 27"D	179	\$4,013.00
24850020	DMXS-48S	120V, 1260W, 10.5 Amps	23"H x 48"W x 27"D	204	\$4,242.00
25450020	DMXS-54S	120V, 1400W, 11.7 Amps	23"H x 54"W x 27"D	220	\$4,651.00
26050020	DMXS-60S	120V, 1560W, 13.0 Amps	23"H x 60"W x 27"D	226	\$5,232.00
Racer® Slanted Display Merchandiser - Double Shelf					
23050040	DMXD-30S	120V, 1380W, 11.5 Amps	32 3/4"H x 30"W x 27"D	181	\$4,980.00
23650040	DMXD-36S	120V, 1680W, 14 Amps	32 3/4"H x 36"W x 27"D	215	\$5,357.00
24250040	DMXD-42S	120V, 1965W, 16.4 Amps	32 3/4"H x 42"W x 27"D	230	\$5,865.00
24850041	DMXD-48S	208V, 2470W, 10.3 Amps	32 3/4"H x 48"W x 27"D	260	\$6,414.00
25450041	DMXD-54S	208V, 2725W, 11.4 Amps	32 3/4"H x 54"W x 27"D	288	\$7,013.00
26050041	DMXD-60S	208V, 3045W, 12.7 Amps	32 3/4"H x 60"W x 27"D	285	\$7,552.00
Flip-up Door Options					
Contact CS	Specify	Flip-up Doors on Front or Back 30" models			\$148.00
Contact CS	Specify	Flip-up Doors on Front or Back 36" models			\$179.00
Contact CS	Specify	Flip-up Doors on Front or Back 42" models			\$207.00
Contact CS	Specify	Flip-up Doors on Front or Back 48" models			\$238.00
Contact CS	Specify	Flip-up Doors on Front or Back 54" models			\$266.00
Contact CS	Specify	Flip-up Doors on Front or Back 60" models			\$294.00
Color Options – Black, Blue, Green, Red, White & Yellow					
Specify	Single, Front				\$144.00
Specify	Single, Channel				\$43.00
Specify	Single, Side				\$116.00
Specify	Double, Front				\$150.00
Specify	Double, Channel				\$73.00
Specify	Double, Side				\$144.00

Food Well

SERIES

Food Wells

APW Wyott is the leading choice for multiple hot food wells, built in a modular configuration and easily installed in your operation. Whether you want one or six wells, equipped with drains, no drains, or our innovative "EZ-Fill" design, or built with a variety of electrical options...APW Wyott's Multiple Food Well line has the version for you. High performance is designed into each unit...High Watt Heating Systems to generate the fastest startup time and recoveries, plus fully insulated boxes that focus all the energy toward the wells (and your product). All units are fully approved for electrical and food safety and are ready to install into your counter area.

Insulated Multiple Hot Food Wells

Fully insulated with recessed bezel. Infinite controls are standard except the HFW-1 has a thermostat. Thermostat is available on Multiple Wells. Single phase is standard, 3 phase is available. Model HFW-1 cannot be converted to 3 phase. All wells have 1 1/2" flange. For drain and manifold, add "D" to model number. Pans are removable. Models HFW-6 and HFW-6D are not CE listed. Models HFW-2, HFW-3, HFW-4, HFW-5 and HFW-6 cannot ship UPS. If shipping via air freight, dimensional weights apply. Backed by APW's One Year Warranty. FOB Standex Dock, freight class 100.



Part Number	Model	Description	Electric	Weight (lbs)	Price
56449	HFW-1	1 each 12 x 20 well w/o drain	120V, 1500W, 12.5 Amps	24	\$751.00
56444	HFW-1	1 each 12 x 20 well w/o drain	208/240V, 1200/1600W, 5.8/6.7 Amps	24	\$751.00
56445	HFW-1D	1 each 12 x 20 well w/drain	120V, 1500W, 12.5 Amps	25	\$825.00
56440	HFW-1D	1 each 12 x 20 well w/drain	208/240V, 1200/1600W, 5.8/6.7 Amps	25	\$825.00
54952	HFW-2	2 each 12 x 20 wells w/o drain	208/240V, 2400/3200W, 11.5/13.3 Amps	89	\$1,993.00
57268	HFW-2D	2 each 12 x 20 wells w/drain	120V, 1500W, 12.5 Amps	89	\$2,112.00
56192	HFW-2D	2 each 12 x 20 wells w/drain	208/240V, 2400/3200W, 11.5/13.3 Amps	89	\$2,112.00
Contact CS	HFW-3	3 each 12 x 20 wells w/o drain	120V, 1500W, 12.5 Amps	139	\$2,618.00
54953	HFW-3	3 each 12 x 20 wells w/o drain	208/240V, 3600/4800W, 17.3/20.0 Amps	139	\$2,618.00
56193	HFW-3D	3 each 12 x 20 wells w/drain	208/240V, 3600/4800W, 17.3/20.0 Amps	139	\$2,873.00
54954	HFW-4	4 each 12 x 20 wells w/o drain	208/240V, 4800/6400W, 23.1/26.7 Amps	169	\$3,418.00
56194	HFW-4D	4 each 12 x 20 wells w/drain	208/240V, 4800/6400W, 23.1/26.7 Amps	169	\$4,047.00
54955	HFW-5	5 each 12 x 20 wells w/o drain	208/240V, 6000/8000W, 28.8/33.3 Amps	199	\$4,280.00
56195	HFW-5D	5 each 12 x 20 wells w/drain	208/240V, 6000/8000W, 28.8/33.3 Amps	199	\$4,944.00
54956	HFW-6	6 each 12 x 20 wells w/o drain	208/240V, 7200/9600W, 34.6/40.0 Amps	251	\$5,906.00
56196	HFW-6D	6 each 12 x 20 wells w/drain	208/240V, 7200/9600W, 34.6/40.0 Amps	251	\$6,700.00

Food Well

SERIES

Slimline Insulated Multiple Hot Food Wells

Fully insulated Slimline multi-wells with recessed bezel. Infinite controls are standard. Single phase is standard. 3 phase is available. All wells have 1-1/2" flange. Models cannot ship UPS. If shipping via air freight, dimensional weights apply. Backed by APW's One Year Warranty. FOB Standex Dock, freight class 100.



Part Number	Model	Description	Electric	Weight (lbs)	Price
HFWS2X4C	HFWS-2	2 each 12 x 20 wells w/o drain	208/240V, 2400/3200W, 11.5/13.3 Amps	89	\$2,182.00
HFWS2D4C	HFWS-2D	2 each 12 x 20 wells w/drain	208/240V, 2400/3200W, 11.5/13.3 Amps	89	\$2,227.00
HFWS3X4C	HFWS-3	3 each 12 x 20 wells w/o drain	208/240V, 3600/4800W, 17.3/20.0 Amps	139	\$2,846.00
HFWS3D4C	HFWS-3D	3 each 12 x 20 wells w/drain	208/240V, 3600/4800W, 17.3/20.0 Amps	139	\$3,074.00
HFWS4X4C	HFWS-4	4 each 12 x 20 wells w/o drain	208/240V, 4800/6400W, 23.1/26.7 Amps	169	\$3,765.00
HFWS4D4C	HFWS-4D	4 each 12 x 20 wells w/drain	208/240V, 4800/6400W, 23.1/26.7 Amps	169	\$4,204.00

See Terms and Conditions in Price list for custom product policies on ordering food wells.

Insulated Multiple Hot Food Wells with Attached Controls & Plug

Heavy-duty top mount insulated rectangular drop-in food wells are designed for direct installation into metal or wood countertops by plugging the unit directly into an existing outlet. The control box is mounted directly to the bottom of the unit. Units are 12.71" high. Units shipped with drain are provided with stainless steel 1/2" NPT drain welded to the bottom of the pan and provided with a removable screen. If shipping via air freight, dimensional weights apply. Backed by APW's One Year Warranty. FOB Standex Dock, freight class 100.



Part Number	Model	Description	Electric	Weight (lbs)	Price
70107000	HFWAT-2	2 each - 12" x 20" w/o drain	120V, 1700W, 14.2 Amps	48	\$2,163.00
70107070	HFWAT-2	2 each - 12" x 20" w/o drain	208V, 1700W, 8.2 Amps	48	\$2,163.00
70107064	HFWAT-2	2 each - 12" x 20" w/drain	240V, 1700W, 7.1 Amps	48	\$2,163.00
70107012	HFWAT-2D	2 each - 12" x 20" w/drain	120V, 1700W, 14.2 Amps	48	\$2,292.00
70107072	HFWAT-2D	2 each - 12" x 20" w/drain	208V, 1700W, 8.2 Amps	48	\$2,292.00
70107074	HFWAT-2D	2 each - 12" x 20" w/drain	240V, 1700W, 7.1 Amps	48	\$2,292.00
70107018	HFWAT-3	3 each - 12" x 20" w/o drain	208V, 2550W, 12.3 Amps	68	\$2,884.00
70107065	HFWAT-3	3 each - 12" x 20" w/o drain	240V, 2550W, 10.6 Amps	68	\$2,884.00
70107013	HFWAT-3D	3 each - 12" x 20" w/drain	208V, 2550W, 12.3 Amps	68	\$3,163.00
70107075	HFWAT-3D	3 each - 12" x 20" w/drain	240V, 2550W, 10.6 Amps	68	\$3,163.00
70107049	HFWAT-4	4 each - 12" x 20" w/o drain	208V, 3400W, 16.3 Amps	98	\$3,765.00
70107066	HFWAT-4	4 each - 12" x 20" w/o drain	240V, 3400W, 14.2 Amps	98	\$3,765.00
70107014	HFWAT-4D	4 each - 12" x 20" w/drain	208V, 3400W, 16.3 Amps	98	\$4,414.00
70107076	HFWAT-4D	4 each - 12" x 20" w/drain	240V, 3400W, 14.2 Amps	98	\$4,414.00
70107054	HFWAT-5	5 each - 12" x 20" w/o drain	208V, 4250W, 20.4 Amps	118	\$4,485.00
70107067	HFWAT-5	5 each - 12" x 20" w/o drain	240V, 4250W, 17.7 Amps	118	\$4,485.00
70107015	HFWAT-5D	5 each - 12" x 20" w/drain	208V, 4250W, 20.4 Amps	118	\$5,500.00
70107077	HFWAT-5D	5 each - 12" x 20" w/drain	240V, 4250W, 17.7 Amps	118	\$5,500.00
70107028	HFWAT-6	6 each - 12" x 20" w/o drain	208V, 5100W, 24.5 Amps	260	\$5,853.00
70107068	HFWAT-6	6 each - 12" x 20" w/o drain	240V, 5100W, 21.3 Amps	260	\$5,853.00
70107016	HFWAT-6D	6 each - 12" x 20" w/drain	208V, 5100W, 24.5 Amps	260	\$5,906.00
70107078	HFWAT-6D	6 each - 12" x 20" w/drain	240V, 5100W, 21.3 Amps	260	\$5,906.00

Food Well

SERIES

Insulated EZ-Fill Multiple Hot Food Wells

Fully insulated EZ-Fill multi-wells are equipped with a self-regulating water fill system that supplies and maintains the correct water level in each well pan. Standard with drain and thermostatic controls only. Single phase is standard. All wells have 1 1/2" flange. Model HFWEZ-12D is not NSF, UL Sanitation, or CUL approved. Only models HFWEZ-12D and HFWEZ-1D can ship UPS. If shipping via air freight, dimensional weights apply. Backed by APW's One Year Warranty. FOB Standex Dock, freight class 100.

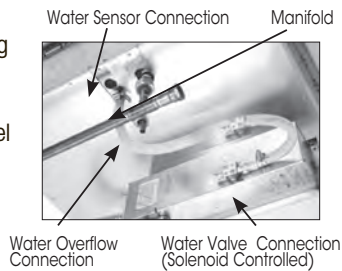

Part Number	Model	Description	Electric	Weight (lbs)	Price
EZ12D4B	HFWEZ-12D	1/2 size 12 x 10 w/drain	208/240V, 1200/1600W, 5.8/6.7 Amps	22	\$1,462.00
EZ1D4B	HFWEZ-1D	1 each 12 x 20 well w/drain	208/240V, 1200/1600W, 5.8/6.7 Amps	24	\$1,564.00
EZ2D4B	SHFWEZ-2D	2 each 12 x 20 wells w/drain	208/240V, 2400/3200W, 11.5/13.3 Amps	89	\$3,018.00
EZ3D4B	SHFWEZ-3D	3 each 12 x 20 wells w/drain	208/240V, 3600/4800W, 17.3/20.0 Amps	139	\$3,757.00
EZ4D4B	SHFWEZ-4D	4 each 12 x 20 wells w/drain	208/240V, 4800/6400W, 23.1/26.7 Amps	169	\$5,092.00
EZ5D4B	SHFWEZ-5D	5 each 12 x 20 wells w/drain	208/240V, 6000/8000W, 28.8/33.3 Amps	199	\$6,247.00
EZ6D4B	SHFWEZ-6D	6 each 12 x 20 wells w/drain	208/240V, 7200/9600W, 34.6/40.0 Amps	251	\$7,381.00

UL Listed Uninsulated Top Mount Hot Food Wells 12"x20" with EZ Lock

Top Mount UL listed uninsulated Top Mount Hot Food Wells are supplied with a complete UL approved electrical kit, including an electrical conduit, control box and bezel. Flange is 3/4". Thermostatic controls. Steel element support stabilizes heating element and reflects heat toward food. Unit is standard with EZ locks for easy installation. 3/4" Flange. Units with drain have a 1/2" NPT (National Pipe Thread) drain. If shipping via air freight, dimensional weights apply. Backed by APW's One Year Warranty. FOB Standex Dock, freight class 100.



Part Number	Model	Description	Electric	Weight (lbs)	Price
Energy Efficient Models					
55496-36UL	TM-90 UL	w/o drain	120V, 750W, 6.3 Amps	23	\$681.00
55363-36UL	TM-90D UL	w/drain	120V, 750W, 6.3 Amps	23	\$737.00
High Performance, Fast Recovery Models					
55495-36UL	TM-90 UL	w/o drain	120V, 1200W, 10 Amps	23	\$681.00
55489-36UL	TM-90 UL	w/o drain	208V, 1600W, 7.7 Amps	23	\$681.00
55491-36UL	TM-90 UL	w/o drain	208/240V, 1200/1600W, 5.8/6.7 Amps	23	\$681.00
55490-36UL	TM-90 UL	w/o drain	208/240/277V, 900/1200/1600W, 4.33/5/5.8 Amps	23	\$681.00
55364-36UL	TM-90D UL	w/drain	120V, 1200W, 10 Amps	23	\$737.00
55450-36UL	TM-90D UL	w/drain	208V, 1600W, 7.7 Amps	23	\$737.00
55365-36UL	TM-90D UL	w/drain	208/240V, 1200/1600W, 5.8/6.7 Amps	23	\$737.00
55366-36UL	TM-90D UL	w/drain	208/240/277V, 900/1200/1600W, 4.33/5/5.8 Amps	23	\$737.00

Food Well

SERIES

Uninsulated Top Mount Hot Food Wells with EZ Lock

UR Uninsulated Top Mount Hot Food Wells are supplied with thermostatic controls, pilot light and a 3/6" capillary. Unit is standard with EZ locks for easy installation. 3/4" Flange. Units with drain have a 1/2" NPT drain. If shipping via air freight, dimensional weights apply. Backed by APW's One Year Warranty. FOB Standex Dock, freight class 100.



Part Number	Model	Description	Electric	Weight (lbs)	Price
Energy Efficient Models					
55496	TM-90	w/o drain	120V, 750W, 6.25 Amps	23	\$597.00
55363	TM-90D	w/drain	120V, 750W, 6.25 Amps	23	\$634.00
High Performance, Fast Recovery Models					
55495	TM-90	w/o drain	120V, 1200W, 10 Amps	23	\$597.00
55489	TM-90	w/o drain	208V, 1600W, 7.7 Amps	23	\$597.00
55491	TM-90	w/o drain	208/240V, 1200/1600W, 5.8/6.7 Amps	23	\$597.00
55490	TM-90	w/o drain	208/240/277V, 900/1200/1600W, 4.33/5/5.8 Amps	23	\$597.00
55364	TM-90D	w/drain	120V, 1200W, 10 Amps	23	\$634.00
55450	TM-90D	w/drain	208V, 1600W, 7.7 Amps	23	\$634.00
55365	TM-90D	w/drain	208/240V, 1200/1600W, 5.8/6.7 Amps	23	\$634.00
55366	TM-90D	w/drain	208/240/277V, 900/1200/1600W, 4.33/5/5.8 Amps	23	\$634.00

Insulated Fractional Hot Food Wells with EZ Lock

Fully insulated 2/3, 1/2, and 4/3 size hot food wells with recessed control bezel. Standard with thermostatic control and with UL listed. If shipping via air freight, dimensional weights apply. Backed by APW's One Year Warranty. FOB Standex Dock, freight class 100.



Part Number	Model	Description	Electric	Weight (lbs)	Price
56451	HFW-23	2/3 size - 12" x 13" w/o drain	120V, 800W, 6.7 Amps	22	\$1,106.00
56450	HFW-23D	2/3 size - 12" x 13" w/drain	120V, 800W, 6.7 Amps	22	\$1,182.00
56439	HFW-12	1/2 size - 12" x 10" w/o drain	120V, 800W, 6.7 Amps	22	\$1,106.00
56435	HFW-12D	1/2 size - 12" x 10" w/drain	120V, 800W, 6.7 Amps	22	\$1,182.00
57545	HFW-43D	4/3 size - 12" x 27" w/drain	120V, 1800W, 15 Amps / 208V, 1800W, 8.7 Amps	24	\$1,026.00
57543	HFW-43D	4/3 size - 12" x 27" w/drain	208V, 1800W, 8.7 Amps	24	\$1,026.00

Fractional Top Mount Hot Food Wells with EZ Lock

Thermostatically controlled top mount fractional wells available in UL and UR. All TM-12 models are not CSA recognized models. If shipping via air freight, dimensional weights apply. Backed by APW's One Year Warranty. FOB Standex Dock, freight class 100.



Part Number	Model	Description	Electric	Weight (lbs)	Price
Energy Efficient Models					
55214	TM-12L	1/2 long - 6" x 20" w/o drain	120V, 500W, 4.17 Amps	12	\$1,104.00
55215	TM-12LD	1/2 long - 6" x 20" w/ 1/2" drain	120V, 500W, 4.17 Amps	12	\$1,110.00
55214-36UL	TM-12L UL	1/2 long - 6" x 20" w/o drain	120V, 500W, 4.17 Amps	12	\$1,187.00
55215-36UL	TM-12LD UL	1/2 long - 6" x 20" w/ 1/2" drain	120V, 500W, 4.17 Amps	12	\$1,272.00
High Performance, Fast Recovery Models					
55562	TM-43	4/3 size - 12" x 27" w/o drain	120V, 1800W, 15 Amps	23	\$708.00
55216	TM-43	4/3 size - 12" x 27" w/o drain	208V, 1800W, 8.65 Amps	23	\$708.00
55371	TM-43D	4/3 size - 12" x 27" w/1" drain	120V, 1800W, 15 Amps	23	\$781.00
55278	TM-43D	4/3 size - 12" x 27" w/1" drain	208V, 1800W, 8.65 Amps	23	\$781.00
55562-36UL	TM-43 UL	4/3 size - 12" x 27" w/o drain	120V, 1800W, 8.65 Amps	23	\$849.00
55279-36UL	TM-43 UL	4/3 size - 12" x 27" w/o drain	208V, 1800W, 8.65 Amps	23	\$849.00
55371-36UL	TM-43D UL	4/3 size - 12" x 27" w/1" drain	120V, 1800W, 8.65 Amps	23	\$925.00
55278-36UL	TM-43D UL	4/3 size - 12" x 27" w/1" drain	208/240V, 1200/1800W, 5.76/6.67 Amps	23	\$925.00

*Standard on UL units

Food Well

SERIES

UL Listed Round Soup Wells Drop-In with EZ Lock

Round, UL listed, un-insulated wells are available in 4, 7, and 11 quarts. Circular element design provides efficient heat transfer. Thermostatically controlled. Available with or without drain. Comes standard with 3/6" conduit to shield wiring, stainless steel control box and bezel. Models SM-50-4 and SM-50-4D are not CSA approved. One year parts and labor. If shipping via air freight, dimensional weights apply. Backed by APW's One Year Warranty. FOB Standex Dock, freight class 100.



Part Number	Model	Description	Electric	Weight (lbs)	Price
Energy Efficient Models					
56665-36UL	SM-50-4 UL	6 1/2" - 4 qt., w/o drain	120V, 400W, 3.3 Amps	9	\$644.00
56667-36UL	SM-50-4D UL	6 1/2" - 4 qt., w/drain	120V, 400W, 3.3 Amps	9	\$706.00
Energy Efficient Models					
50825-36UL	SM-50-7 UL	8 1/2" - 7 qt., w/o drain	120V, 800W, 4.2 Amps	11	\$583.00
50826-36UL	SM-50-7D UL	8 1/2" - 7 qt., w/drain	120V, 800W, 4.2 Amps	11	\$625.00
High Performance, Fast Recovery Models					
50815-36UL	SM-50-7 UL	8 1/2" - 7 qt., w/o drain	120V, 500W, 6.7 Amps	11	\$583.00
50820-36UL	SM-50-7 UL	8 1/2" - 7 qt., w/o drain	208/240V, 500/660W, 2.4/2.8 Amps	11	\$583.00
55367-36UL	SM-50-7D UL	8 1/2" - 7 qt., w/drain	120V, 500W, 6.7 Amps	11	\$625.00
55368-36UL	SM-50-7D UL	8 1/2" - 7 qt., w/drain	208/240V, 500/660W, 2.4/2.8 Amps	11	\$625.00
High Performance, Fast Recovery Models					
51015-36UL	SM-50-11 UL	10 1/2" - 11 qt., w/o drain	120V, 500W, 4.2 Amps	12	\$569.00
51020-36UL	SM-50-11 UL	10 1/2" - 11 qt., w/o drain	208/240V, 500/660W 2.4/2.8 Amps	12	\$569.00
55369-36UL	SM-50-11D UL	10 1/2" - 11 qt., w/drain	120V, 500W, 4.2 Amps	12	\$629.00
55370-36UL	SM-50-11D UL	10 1/2" - 11 qt., w/drain	208/240V, 500/660W, 2.4/2.8 Amps	12	\$629.00

Round Soup Wells Drop-In with EZ Lock

Round, un-insulated UL recognized round wells come standard with 3/6" control wiring (effective length-26") and increase-decrease dial plate. Warranty: One-year parts and labor. Model SM-50-4 and SM-50-4D are not CSA listed. If shipping via air freight, dimensional weights apply. Backed by APW's One Year Warranty. FOB Standex Dock, freight class 100.



Part Number	Model	Description	Electric	Weight (lbs)	Price
Energy Efficient Models					
56665	SM-50-4	6 1/2" - 4 qt., w/o drain	120V, 400W, 3.3 Amps	4	\$517.00
56667	SM-50-4D	6 1/2" - 4 qt., w/drain	120V, 400W, 3.3 Amps	4	\$577.00
50815	SM-50-7	8 1/2" - 7 qt., w/o drain	120V, 500W, 4.1 Amps	8	\$467.00
50820	SM-50-7	8 1/2" - 7 qt., w/o drain	208/240V, 500/660W, 2.4/2.8 Amps	8	\$467.00
55367	SM-50-7D	8 1/2" - 7 qt., w/drain	120V, 500W, 4.1 Amps	8	\$538.00
55368	SM-50-7D	8 1/2" - 7 qt., w/drain	208/240V, 500/660W, 2.4/2.8 Amps	8	\$538.00
51015	SM-50-11	10 1/2" - 11 qt., w/o drain	120V, 500W, 4.1 Amps	10	\$492.00
51020	SM-50-11	10 1/2" - 11 qt., w/o drain	208/240V, 500/660W, 2.4/2.8 Amps	10	\$492.00
55369	SM-50-11D	10 1/2" - 11 qt., w/drain	120V, 500W, 4.1 Amps	10	\$547.00
55370	SM-50-11D	10 1/2" - 11 qt., w/drain	208/240V, 500/660W, 2.4/2.8 Amps	10	\$547.00
High Performance, Fast Recovery Models					
50825	SM-50-7	8 1/2" - 7 qt., w/o drain	120V, 800W, 6.7 Amps	8	\$467.00
50826	SM-50-7D	8 1/2" - 7 qt., w/drain	120V, 800W, 6.7 Amps	8	\$538.00
50827	SM-50-11	10 1/2" - 11 qt., w/o drain	120V, 800W, 6.7 Amps	10	\$492.00
50828	SM-50-11D	10 1/2" - 11 qt., w/drain	120V, 800W, 6.7 Amps	10	\$547.00

EZ-Fill Round Soup Wells Drop-In with EZ Lock

Has all the same features as standard UL Round Soup Wells, with the benefit of EZ-Fill. Un-insulated EZ-Fill Soup Well is equipped with a self-regulating water fill system that supplies and maintains the correct water level in the soup well pan. Comes standard with drain, thermostatic controls and wood mounting kit. Single Phase. Backed by APW's One Year Warranty. FOB Standex Dock, freight class 100.



Part Number	Model	Description	Electric	Weight (lbs)	Price
EZSM50-7D	SM-50-EZ-7D	10 1/2" - 7 qt., EZ-Fill w/drain	208/240V 500/660W	15	\$1,417.00
70501023	SM-50-EZ-11D	11 qt., EZ-Fill w/drain	208/240V 500/660W	15	\$1,417.00

Food Well

SERIES

Top Mount Round Wells with Immersible Element

Heavy-duty top mount insulated round drop-in food well is designed for installation in metal or wood countertop if optional wood mounting kits provided. The immersible heating element provides quick recovery. The unit is designed to accommodate an 11 qt. round inset. Unit must be used wet. If shipping via air freight, dimensional weights apply. Backed by APW's One Year Warranty, FOB Standex Dock, freight class 100.



Part Number	Model	Description	Electric	Weight (lbs)	Price
56251	CH-11D	12 1/2" - 11 qt., with drain	120V, 1650W	12	\$1,049.00

Insulated Bottom Mount Hot Food Wells 12"x20"

Heavy-duty bottom mount insulated UL recognized wells designed for use in larger systems such as steam tables or kiosks. Comes standard with 36" control wires and increase-decrease faceplate. Dimensions: 8 5/16"H X 13 13/16"W X 21 3/4"L. Warranty: One-year parts and labor. If shipping via air freight, dimensional weights apply. Backed by APW's One Year Warranty, FOB Standex Dock, freight class 100.



Part Number	Model	Description	Electric	Weight (lbs)	Price
Energy Efficient Models					
55486	BM-80	w/o drain	120V, 750W, 6.25 Amps	20	\$600.00
55480	BM-80	w/o drain	208/240/277V, 900/1200/1600W, 4.33/5/5.8 Amps	20	\$600.00
55351	BM-80D	w/drain	120V, 750W, 6.25 Amps	20	\$637.00
55360	BM-80D	w/drain	208/240/277V, 900/1200/1600W, 4.33/5/5.8 Amps	20	\$637.00
55352	BM-80C	w/ square corners	120V, 750W, 6.25 Amps	20	\$600.00
55361	BM-80C	w/ square corners	208/240/277V, 900/1200/1600W, 4.33/5/5.8 Amps	20	\$600.00
55353	BM-80CD	w/drain & square corners	120V, 750W, 6.25 Amps	20	\$637.00
55359	BM-80CD	w/drain & square corners	208/240V, 1200/1600W, 4.33/5 Amps	20	\$637.00
High Performance, Fast Recovery Models					
55485	BM-80	w/o drain	120V, 1200W, 10 Amps	20	\$600.00
55481	BM-80	w/o drain	208/240V, 1200/1600W, 7.7 Amps	20	\$600.00
55354	BM-80D	w/drain	120V, 1200W, 10 Amps	20	\$637.00
55357	BM-80D	w/drain	208/240V, 1200/1600W, 7.7 Amps	20	\$637.00
55355	BM-80C	w/ square corners	120V, 1200W, 10 Amps	20	\$600.00
56298	BM-80C	w/ square corners	208V, 1600W, 7.7 Amps	20	\$600.00
55356	BM-80CD	w/drain & square corners	120V, 1200W, 10 Amps	20	\$637.00
55362	BM-80CD	w/drain & square corners	208/240/277V, 900/1200/1600W, 7.7 Amps	20	\$637.00

Uninsulated Bottom Mount Hot Food Wells 12"x 20"

Economical and heavy-duty bottom mount un-insulated UL recognized wells are a component part for customized built-in stainless counters. Comes standard with 36" control wiring and increase-decrease faceplate. Dimensions: 8 1/2"H X 12 3/16"W X 20-1/8"L. Warranty: One-year parts and labor. If shipping via air freight, dimensional weights apply. Backed by APW's One Year Warranty, FOB Standex Dock, freight class 100.



Part Number	Model	Description	Electric	Weight (lbs)	Price
Energy Efficient Models					
55436	BM-30	w/o drain	120V, 750W, 6.25 Amps	20	\$557.00
55431	BM-30	w/o drain	208/240V, 1200/1600W	20	\$557.00
55303	BM-30D	w/drain	120V, 750W, 6.25 Amps	20	\$613.00
55320	BM-30D	w/drain	208/240V, 1200/1600W	20	\$613.00
High Performance, Fast Recovery Models					
55435	BM-30	w/o drain	120V, 1200W, 10 Amps	20	\$557.00
55430	BM-30	w/o drain	208/240/277V, 900/1200/1600W, 4.33/5/5.8 Amps	20	\$557.00
55311	BM-30D	w/drain	120V, 1200W, 10 Amps	20	\$613.00
55444	BM-30D	w/drain	208V, 1600W, 4.33 Amps	20	\$613.00

Food Well

SERIES

UL Listed Insulated Bottom Mount Food Wells 12"x 20"

Bottom mount, fully insulated well designed to meet UL's safety requirement, by including the conduit for shielding the wiring, stainless steel control box and bezel. Unique element formation provides hotter and even heat flow. The square corners model allows for fabrication without die stamping. Thermostatically controlled. Available with or without drain. Dimensions: 8 5/16"H X 13 13/16"W X 21 3/4"L. Warranty: One-year parts and labor. If shipping via air freight, dimensional weights apply. Backed by APW's One Year Warranty. FOB Standex Dock, freight class 100.



Part Number	Model	Description	Electric	Weight (lbs)	Price
Energy Efficient Models					
55486-36UL	BM-80 UL	w/o drain	120V, 750W, 6.25 Amps	24	\$701.00
55480-36UL	BM-80 UL	w/o drain	208/240/277V, 900/1200/1600W, 4.33/5/5.8 Amps	24	\$701.00
55351-36UL	BM-80D UL	w/drain	120V, 750W, 6.25 Amps	24	\$744.00
55360-36UL	BM-80D UL	w/drain	208/240/277V, 900/1200/1600W, 4.33/5/5.8 Amps	24	\$744.00
55352-36UL	BM-80C UL	w/ square corners	120V, 750W, 6.25 Amps	24	\$701.00
55361-36UL	BM-80C UL	w/ square corners	208/240/277V, 900/1200/1600W, 4.33/5/5.8 Amps	24	\$701.00
55353-36UL	BM-80CD UL	w/drain & square corners	120V, 750W, 6.25 Amps	24	\$744.00
55362-36UL	BM-80CD UL	w/drain & square corners	208/240/277V, 900/1200/1600W, 4.33/5/5.8 Amps	24	\$744.00
High Performance, Fast Recovery Models					
55485-36UL	BM-80 UL	w/o drain	120V, 1200W, 10 Amps	24	\$701.00
56300-36UL	BM-80 UL	w/o drain	208V, 1600W, 7.7 Amps	24	\$701.00
55354-36UL	BM-80D UL	w/drain	120V, 1200W, 10 Amps	24	\$744.00
56299-36UL	BM-80D UL	w/drain	208V, 1600W, 7.7 Amps	24	\$744.00
55355-36UL	BM-80C UL	w/ square corners	120V, 1200W, 10 Amps	24	\$701.00
56298-36UL	BM-80C UL	w/ square corners	208V, 1600W, 7.7 Amps	24	\$701.00
55356-36UL	BM-80CD UL	w/drain & square corners	120V, 1200W, 10 Amps	24	\$744.00
56297-36UL	BM-80CD UL	w/drain & square corners	208V, 1600W, 7.7 Amps	24	\$744.00

UL Listed Uninsulated Bottom Mount Hot Food Wells 12"x 20"

Bottom mount UL listed un-insulated wells provide an uninterrupted stainless steel countertop. The unique element contour provides hot and even heat distribution. Thermostatically controlled. Available with or without drain. As required by UL these units come standard with conduit for shielding the control wires, control box and bezel. Four voltages available. Dimensions: 8 1/2"H X 12 3/16"W X 20 1/8" L. Warranty: One-year parts and labor. If shipping via air freight, dimensional weights apply. Backed by APW's One Year Warranty. FOB Standex Dock, freight class 100.



Part Number	Model	Description	Electric	Weight (lbs)	Price
Energy Efficient Models					
55436-36UL	BM-30 UL	w/o drain	120V, 750W, 6.25 Amps	23	\$645.00
55430-36UL	BM-30 UL	w/o drain	208/240/277V, 750W	23	\$645.00
55303-36UL	BM-30D UL	w/drain	120V, 750W, 6.25 Amps	23	\$722.00
55326-36UL	BM-30D UL	w/drain	208/240/277V, 1600W	23	\$722.00
High Performance, Fast Recovery Models					
55435-36UL	BM-30 UL	w/o drain	120V, 1200W, 10 Amps	23	\$645.00
55431-36UL	BM-30 UL	w/o drain	208/240/277V, 900/1200/1600W, 4.33/5/5.8 Amps	23	\$645.00
55311-36UL	BM-30D UL	w/drain	120V, 1200W, 10 Amps	23	\$722.00
55320-36UL	BM-30D UL	w/drain	208/240V, 1200/1600W, 4.33/5 Amps	23	\$722.00

Insulated 26" x 20" Bottom Mount Hot Food Well

Fully insulated. Single Insulated heavy gauge galvanized steel wrapper. Standard with thermostatic control and 36" exposed capillary. Holds (2) 12x20 full size pans 6" deep and also will accommodate 1 full size (18" x 26") bun pan. All required adapters included. Drain screen provided with FW-2026D (stainless steel drain coupling). If shipping via air freight, dimensional weights apply. Backed by APW's One Year Warranty. FOB Standex Dock, freight class 100.



Part Number	Model	Description	Electric	Weight (lbs)	Price
56226	FW-2026	Hot Food Well (holds 2 12x20 pans w/o drain)	208/240V, 2400/3200W, 11.5/13.4 Amps	46	\$2,062.00
56225	FW-2026D	Hot Food Well (holds 2 12x20 pans w/drain)	208/240V, 2400/3200W, 11.5/13.4 Amps	46	\$2,116.00

Food Well

SERIES

Foodwell Options

Options			
Specify	3 Phase (Cost Per Well)	Only on 3 well up to 6 well	\$43.00
Specify	72" Control Conduit Wiring Per Well	Thermostat or Infinite models only	\$75.00
56420	Drain Kit and Shut Off Valve	Includes 1/2" NPT Nipple S.S. & 3' high temp hose	\$152.00
55346-PK	Electrical Code Kit – 36" (Bezel, Conduit, Junction Box)	Thermostat and Wires	\$186.00
55347-PK	Electrical Code Kit – 72" (Bezel, Conduit, Junction Box)	Thermostat and Wires	\$218.00
55492-PK	Electrical Code Kit – 36" 120V (Bezel, Conduit, Junction Box)	Infinite and Wires	\$152.00
55493-PK	Electrical Code Kit – 36" 208V (Bezel, Conduit, Junction Box)	Infinite and Wires	\$152.00
55494-PK	Electrical Code Kit – 36" 240V (Bezel, Conduit, Junction Box)	Infinite and Wires	\$152.00
55497-PK	Electrical Code Kit – 72" 120V (Bezel, Conduit, Junction Box)	Infinite and Wires	\$223.00
55498-PK	Electrical Code Kit – 72" 208V (Bezel, Conduit, Junction Box)	Infinite and Wires	\$223.00
55499-PK	Electrical Code Kit – 72" 240V (Bezel, Conduit, Junction Box)	Infinite and Wires	\$223.00
56360	Lever Operated Shut-Off Valve Only		\$123.00
56370	Recessed Bezel		\$63.00
Specify	Thermostat (Cost Per Well)		\$78.00
56431	Wood Mounting Kit, 12" x 20"	HFW-1	\$98.00
55313	Wood Mounting Kit, 12" x 20"	TM-90	\$95.00
55087	Wood Mounting Kit, 2 Well		\$152.00
56413	Wood Mounting Kit, 1/2 Size	HFW-12	\$98.00
56460	Wood Mounting Kit, 2/3 Size	HFW-23	\$98.00
55286	Wood Mounting Kit, 4 qt	SM-4	\$79.00
55333	Wood Mounting Kit, 7 qt	SM-7	\$88.00
55323	Wood Mounting Kit, 11 qt	SM-11	\$96.00
55317	Wood Mounting Kit, 4/3 unit	TM-43	\$124.00

Cold/Hot Dual Temp Wells

Single control switch for changing from hot to cold operation. Automatic water fill and high limit thermostat element protection is provided for hot operation. The positive-off thermostat controls the element allowing for adjustability and increased consistency of temperatures. Flexible 24" long conduit connects stainless steel control panel for optional counter mounting. Units are designed for installation into a wood or metal counter fixture. If shipping via air freight, dimensional weights apply. If shipping via air freight, dimensional weights apply. Backed by APW's One Year Warranty. FOB Standex Dock, freight Class 70.



Part Number	Model	Description	Dimensions	Weight (lbs)	Price
21829000	CHDT-2	120/208-240V, 1/4hp, 14.5/15.9Amp	32 3/4 W x 27 1/8"D	215	\$9,575.00
21829100	CHDT-3	120/208-240V, 1/3hp, 21.4/23.7Amp	46 3/4 W x 27 1/8"D	243	\$10,006.00
21829200	CHDT-4	120/208-240V, 1/2hp, 25.6/28.3Amp	60 3/4 W x 27 1/8"D	288	\$11,138.00
21829300	CHDT-5	120/208-240V, 3/4hp, 44.2/48.6Amp	74 3/4 W x 27 1/8"D	298	\$12,142.00
21829400	CHDT-6	120/208-240V, 3/4hp, 44.2/48.6Amp	87 3/4 W x 27 1/8"D	320	\$12,501.00

Food Well

SERIES

Drop-In Non-Refrigerated Ice Pans

The Countertop Drop-In Ice Pan provides an economic solution to the cost of in-counter cold storage. Uses ice below pans for cooling. Stainless steel top frame, stainless steel liner, aluminized steel outer liner 2" polyurethane foamed in place insulation. Backed by APW's One Year Warranty. FOB Standex Dock, freight class 70.



Part Number	Model	Description	Exterior Dimensions	Weight (lbs)	Price
30060175	ICP-100	Stainless Steel Construction	19 1/2"H x 28"W x 11 13/16"D	72	\$1,391.00
30060275	ICP-200	Stainless Steel Construction	28"H x 32 13/16"W x 11 13/16"D	126	\$1,606.00
30060375	ICP-300	Stainless Steel Construction	28"H x 46 1/8"W x 11 13/16"D	150	\$1,896.00
30060476	ICP-400	Stainless Steel Construction	28"H x 59 7/16"W x 11 13/16"D	180	\$2,190.00
30060576	ICP-500	Stainless Steel Construction	28"H x 72 3/4"W x 11 13/16"D	274	\$2,484.00
30060675	ICP-600	Fits 6 Standard 12"x20" Pans	25 3/8"H x 86"W x 9 3/4"D	290	\$2,638.00
Curved Models					
Contact CS	ICPC-200	Fits 2 Standard 12"x20" Pans	21.80"H x 40 1/2"W x 26 1/16"D	100	\$2,055.00
30070285	ICPC-300	Fits 3 Standard 12"x20" Pans	21.80"H x 57 1/4"W x 26 1/16"D	118	\$2,532.00
30070280	ICPC-400	Fits 4 Standard 12"x20" Pans	21.80"H x 73 11/16"W x 26 1/16"D	145	\$2,878.00
Contact CS	ICPC-500	Fits 5 Standard 12"x20" Pans	21.80"H x 89 7/8"W x 26 1/16"D	164	\$3,260.00
Narrow Models					
30070275	ICPN-200	Fits 2 Standard 12"x20" Pans	21 7/8"H x 32 13/16"W x 11 13/16"D	126	\$1,942.00
30070270	ICPN-300	Fits 3 Standard 12"x20" Pans	28"H x 46 1/8"W x 11 13/16"D	150	\$3,341.00

Drop-In Refrigerated Cold Wells

Refrigeration system is 1/5 hp for one pan units, and 1/4 hp for two, three and four pan units. The five pan unit is 1/3 hp. Units are single phase, 120V, with adjustable temperature control and lighted power switch. Drains are standard. All models cannot ship UPS. For export, add \$250. If shipping via air freight, dimensional weights apply. Backed by APW's One Year Warranty. FOB Standex Dock, freight Class 70.



Part Number	Model	Description	Electric	Dimensions	Cut-Outs	Weight (lbs)	Price	
30060100	CW-1	1 pan	120V, 1/5 hp, 4 Amps	28"L x 19 1/2"W x 23 13/16"H	26 1/2" x 18"	121	\$3,989.00	
30060123	CW-1	1 pan	230V, 1/5 hp, 2 Amps	28"L x 19 1/2"W x 23 13/16"H	26 1/2" x 18"	121	\$3,989.00	
30060200	CW-2	2 pans	120V, 1/4 hp, 4 Amps	32 13/16"L x 28"W x 23 13/16"H	26 1/2" x 31 5/16"	179	\$4,477.00	
30060223	CW-2	2 pans	230V, 1/4 hp, 2 Amps	32 13/16"L x 28"W x 23 13/16"H	26 1/2" x 31 5/16"	179	\$4,477.00	
30060300	CW-3	3 pans	120V, 1/4 hp, 4 Amps	46 1/8"L x 28"W x 23 13/16"H	26 1/2" x 44 5/8"	203	\$4,729.00	
30060323	CW-3	3 pans	230V, 1/4 hp, 3 Amps	46 1/8"L x 28"W x 23 13/16"H	26 1/2" x 44 5/8"	203	\$4,729.00	
30060400	CW-4	4 pans	120V, 1/4 hp, 4 Amps	59 7/16"L x 28"W x 23 13/16"H	26 1/2" x 57 15/16"	233	\$5,042.00	
30060423	CW-4	4 pans	230V, 1/4 hp, 2 Amps	59 7/16"L x 28"W x 23 13/16"H	26 1/2" x 57 15/16"	233	\$5,042.00	
30060500	CW-5	5 pans	120V, 1/3 hp, 5 Amps	72 3/4"L x 28"W x 23 13/16"H	26 1/2" x 71 1/4"	327	\$5,483.00	
30060523	CW-5	5 pans	230V, 1/3 hp, 2.8 Amps	72 3/4"L x 28"W x 23 13/16"H	26 1/2" x 71 1/4"	327	\$5,483.00	
30060650	CW-6	6 pans	120V, 3/4hp, 15.3 Amps	86" L x 25 3/8"W x 24 1/5"H	23 7/8" x 84"	367	\$6,110.00	
Curved Models								
30060225	CWC-2	2 pans	120V, 1/5hp, 4 Amps	40 1/2" L x 26 1/16"D		161	\$5,899.00	
30060325	CWC-3	3 pans	120V, 1/5hp, 4 Amps	57 1/4" L x 26 1/16"D		184	\$6,453.00	
30060425	CWC-4	4 pans	120V, 1/4hp, 7 Amps	73 11/16" L x 26 1/16"D		233	\$6,968.00	
30060525	CWC-5	5 pans	120V, 1/4hp, 7 Amps	89 7/8" L x 26 1/16"D		243	\$7,617.00	
Options								
1800100	COMP-5	5-year Compressor Warranty (Net Price)						\$224.00
21807560	Adaptor Bar 12" for ICP, ICPC, CW and CWC Units							\$16.00
21807565	Adaptor Bar 20" for ICP, ICPC, CW and CWC Units							\$37.00

Food Well

SERIES

Insulated Cold Pans with EZ Lock

Top mount fully insulated cold pans have stainless steel well pans. Units shipped with drains are provided with stainless steel NPT drain welded to bottom of pan and a drain screen. If shipping via air freight, dimensional weights apply. Backed by APW's One Year Warranty. FOB Standex Dock, freight class 100.



Part Number	Model	Description	Exterior Dimensions	Weight (lbs)	Price
56470	CFW-1	Full size cold pan, 12" x 20"	23"H x 15"W x 7 3/4"D	24	\$706.00
56471	CFW-1D	Full size cold pan with drain, 12" x 20"	23"H x 15"W x 7 3/4"D	24	\$760.00
56465	CFW-43	4/3 size cold pan, 12" x 27"	30"H x 15"W x 7 3/4"D	29	\$1,042.00
56466	CFW-43D	4/3 size cold pan with drain, 12" x 27"	30"H x 15"W x 7 3/4"D	29	\$1,059.00
Options					
56420		Drain kit (incl. 1/2" PVC & 3 foot high-temperature hose) & shut-off valve		2	\$142.00

Drop-In Frost Tops & Cold Slabs

Insulated with high density polyurethane foam making them ideal for product demonstration while maintaining product temperatures. Stainless steel louver provided. On/Off power, NSF certified and environmentally friendly HFC-404A refrigerant. Available in Stainless Steel or Granite. Backed by APW's One Year Warranty. FOB Standex Dock, freight class 100.

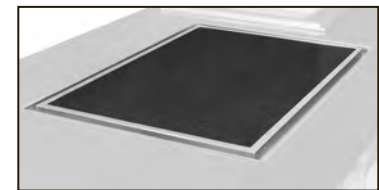

Part Number	Model	Electric	Dimensions	Weight (lbs)	Price
Granite Frost Tops					
31810300	GFT-31	115V, 1/4hp, 7.Amps	30 3/4"W x 25"D	220	\$10,098.00
31810301	GFT-45	115V, 1/4hp, 7 Amps	44 5/8"W x 25"D	288	\$11,559.00
Contact CS	GFT-59	115V, 1/3hp, 8 Amps	58 1/2"W x 25"D	336	\$13,854.00
Contact CS	GFT-73	115V, 1/2hp, 9 Amps	72.38"W x 25"D	424	\$15,199.00
Stainless Steel Frost Tops					
31810000	SFT-31	115V, 1/4hp, 7.5 Amps	30 3/4"W x 25"D	142	\$7,125.00
31810005	SFT-45	115V, 1/4hp, 7.5 Amps	44 5/8"W x 25"D	168	\$9,458.00
31810009	SFT-59	115V, 1/4hp, 7.5 Amps	58 1/2"W x 25"D	193	\$12,661.00
31810003	SFT-73	115V, 1/3hp, 8 Amps	72 3/8"W x 25"D	209	\$13,551.00
31810007	SFT-87	115V, 1/3hp, 8 Amps	86 1/4"W x 25"D	239	\$15,018.00

Drop-In Refrigerated Forced Air Cold Pans

Designed to hold pre-chilled food products at serving temperatures. perfect for merchandising product. Stainless Steel construction with fully insulated walls. Adapter bars are included with each unit to allow use of a variety of different size pans. Environmentally freindly HFC-404A refrigerant. Thermostat for temperature control. Air curtain assembly removable. Backed by APW's One Year Warranty. FOB Standex Dock, freight class 100.

Part Number	Model	Electric	Dimensions	Weight (lbs)	Price
31810200	FACW-2	115V, 1/4hp, 8 Amps	32 3/4"W x 27 1/8"D	165	\$8,258.00
31810203	FACW-3	115V, 1/2hp, 10 Amps	46 3/4"W x 27 1/8"D	175	\$8,932.00
31810204	FACW-4	115V, 1/2hp, 10 Amps	60 3/4"W x 27 1/8"D	225	\$9,524.00
31810205	FACW-5	115V, 3/4hp, 15 Amps	74 3/4"W x 27 1/8"D	235	\$10,089.00
31810206	FACW-6	115V, 3/4hp, 15 Amps	87 3/4"W x 27 1/8"D	255	\$10,773.00

Overhead Warmer

SERIES

Overhead Warmers

APW Wyott® Overhead Warmers provide just the right heat to keep food warm and fresh. Available in multiple lengths and power options, they provide smooth, even heat over pass-throughs and temporary food holding areas of all sizes without wasting unnecessary energy.

Single C*Radiant™ Overhead Warmers

The C*Radiant™ (Ceramic) Overhead Warmers deliver greater heat intensity and efficient infrared radiant energy. High wattage version is superior for highly air conditioned passage-ways. Shipped with Side-Mounted Control Box (standard) or remote control box. For Remote, add "R" to the end of model number. Both options come standard with mounting brackets. Specify 120V, 208V, or 240V. Models FDC-48H to 72H and FDC-54L to 72L available only in 208V and 240V. Single units are 6" wide and 2 1/2" high (Side mounted box adds 4 13/32" to width). If shipping via air freight, dimensional weights apply. Backed by APW's One Year Warranty. FOB Standex Dock, freight class 100. 60" and above must ship LTL.



Part Number	Model	Description	Watts	Weight (lbs)	Price
High Wattage					
70400444	FDC-18H	18" warmer 120V Rocker	700	8	\$627.00
70401444	FDC-18H	18" warmer 208V Rocker	700	8	\$627.00
70402444	FDC-18H	18" warmer 240V Rocker	700	8	\$627.00
70400444-R	FDC-18H	18" warmer 120V Remote Infinite	700	8	\$651.00
70401444-R	FDC-18H	18" warmer 208V Remote Infinite	700	8	\$651.00
70402444-R	FDC-18H	18" warmer 240V Remote Infinite	700	8	\$651.00
70400446	FDC-24H	24" warmer 120V Rocker	800	9	\$632.00
70401446	FDC-24H	24" warmer 208V Rocker	800	9	\$632.00
70402446	FDC-24H	24" warmer 240V Rocker	800	9	\$632.00
70400446-R	FDC-24H	24" warmer 120V Remote Infinite	800	9	\$655.00
70401446-R	FDC-24H	24" warmer 208V Remote Infinite	800	9	\$655.00
70402446-R	FDC-24H	24" warmer 240V Remote Infinite	800	9	\$655.00
70400448	FDC-30H	30" warmer 120V Rocker	1150	10	\$763.00
70401448	FDC-30H	30" warmer 208V Rocker	1150	10	\$763.00
70402448	FDC-30H	30" warmer 240V Rocker	1150	10	\$763.00
70400448-R	FDC-30H	30" warmer 120V Remote Infinite	1150	10	\$788.00
70401448-R	FDC-30H	30" warmer 208V Remote Infinite	1150	10	\$788.00
70402448-R	FDC-30H	30" warmer 240V Remote Infinite	1150	10	\$788.00
70400450	FDC-36H	36" warmer 120V Rocker	1350	12	\$771.00
70401450	FDC-36H	36" warmer 208V Rocker	1350	12	\$771.00
70402450	FDC-36H	36" warmer 240V Rocker	1350	12	\$771.00
70400450-R	FDC-36H	36" warmer 120V Remote Infinite	1350	12	\$797.00
70401450-R	FDC-36H	36" warmer 208V Remote Infinite	1350	12	\$797.00
70402450-R	FDC-36H	36" warmer 240V Remote Infinite	1350	12	\$797.00
70400452	FDC-42H	42" warmer 120V Rocker	1500	13	\$895.00
70401452	FDC-42H	42" warmer 208V Rocker	1500	13	\$895.00
70402452	FDC-42H	42" warmer 240V Rocker	1500	13	\$895.00
70400452-R	FDC-42H	42" warmer 120V Remote Infinite	1500	13	\$917.00
70401452-R	FDC-42H	42" warmer 208V Remote Infinite	1500	13	\$917.00
70402452-R	FDC-42H	42" warmer 240V Remote Infinite	1500	13	\$917.00
70401454	FDC-48H	48" warmer 120V Rocker 2000W	2000	14	\$904.00
70400454	FDC-48H	48" warmer 208V Rocker	2000	14	\$904.00
70402454	FDC-48H	48" warmer 240V Rocker	2000	14	\$904.00
70400454-R	FDC-48H	48" warmer 208V Remote Infinite	2000	14	\$930.00
70402454-R	FDC-48H	48" warmer 240V Remote Infinite	2000	14	\$930.00
70400456	FDC-54H	54" warmer 208V Rocker	2200	15	\$1,034.00
70402456	FDC-54H	54" warmer 240V Rocker	2200	15	\$1,034.00
70400456-R	FDC-54H	54" warmer 208V Remote Infinite	2200	15	\$1,059.00
70402456-R	FDC-54H	54" warmer 240V Remote Infinite	2200	15	\$1,059.00
70400458	FDC-60H	60" warmer 208V Rocker	2700	18	\$1,041.00
70402458	FDC-60H	60" warmer 240V Rocker	2700	18	\$1,041.00
70400460	FDC-66H	66" warmer 208V Rocker	2700	20	\$1,167.00
70402460	FDC-66H	66" warmer 240V Rocker	2700	20	\$1,167.00
70402462	FDC-72H	72" warmer 208V Rocker	3000	22	\$1,197.00
70400462	FDC-72H	72" warmer 240V Rocker	3000	22	\$1,197.00

Continued on next page

Overhead Warmer

SERIES

Single C*Radiant™ Overhead Warmers *Continued*

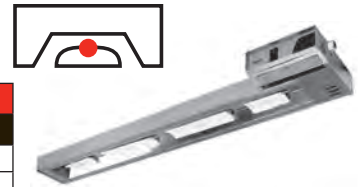

Part Number	Model	Description	Watts	Weight (lbs)	Price
Standard Wattage					
70400443	FDC-18L	18" warmer 120V Rocker	500	8	\$614.00
70401443	FDC-18L	18" warmer 208V Rocker	500	8	\$614.00
70402443	FDC-18L	18" warmer 240V Rocker	500	8	\$614.00
70400443-R	FDC-18L	18" warmer 120V Remote Infinite	500	8	\$640.00
70401443-R	FDC-18L	18" warmer 208V Remote Infinite	500	8	\$640.00
70402443-R	FDC-18L	18" warmer 240V Remote Infinite	500	8	\$640.00
70400445	FDC-24L	24" warmer 120V Rocker	700	9	\$625.00
70401445	FDC-24L	24" warmer 208V Rocker	700	9	\$625.00
70402445	FDC-24L	24" warmer 240V Rocker	700	9	\$625.00
70400445-R	FDC-24L	24" warmer 120V Remote Infinite	700	9	\$647.00
70401445-R	FDC-24L	24" warmer 208V Remote Infinite	700	9	\$647.00
70402445-R	FDC-24L	24" warmer 240V Remote Infinite	700	9	\$647.00
70400447	FDC-30L	30" warmer 120V Rocker	850	10	\$756.00
70401447	FDC-30L	30" warmer 208V Rocker	850	10	\$756.00
70402447	FDC-30L	30" warmer 240V Rocker	850	10	\$756.00
70400447-R	FDC-30L	30" warmer 120V Remote Infinite	850	10	\$778.00
70401447-R	FDC-30L	30" warmer 208V Remote Infinite	850	10	\$778.00
70402447-R	FDC-30L	30" warmer 240V Remote Infinite	850	10	\$778.00
70400449	FDC-36L	36" warmer 120V Rocker	1000	12	\$760.00
70401449	FDC-36L	36" warmer 208V Rocker	1000	12	\$760.00
70402449	FDC-36L	36" warmer 240V Rocker	1000	12	\$760.00
70400449-R	FDC-36L	36" warmer 120V Remote Infinite	1000	12	\$786.00
70401449-R	FDC-36L	36" warmer 208V Remote Infinite	1000	12	\$786.00
70402449-R	FDC-36L	36" warmer 240V Remote Infinite	1000	12	\$786.00
70400451	FDC-42L	42" warmer 120V Rocker	1200	13	\$887.00
70401451	FDC-42L	42" warmer 208V Rocker	1200	13	\$887.00
70402451	FDC-42L	42" warmer 240V Rocker	1200	13	\$887.00
70400451-R	FDC-42L	42" warmer 120V Remote Infinite	1200	13	\$906.00
70401451-R	FDC-42L	42" warmer 208V Remote Infinite	1200	13	\$906.00
70402451-R	FDC-42L	42" warmer 240V Remote Infinite	1200	13	\$906.00
70400453	FDC-48L	48" warmer 120V Rocker	1500	14	\$895.00
70401453	FDC-48L	48" warmer 208V Rocker	1500	14	\$895.00
70402453	FDC-48L	48" warmer 240V Rocker	1500	14	\$895.00
70400453-R	FDC-48L	48" warmer 120V Remote Infinite	1500	14	\$917.00
70401453-R	FDC-48L	48" warmer 208V Remote Infinite	1500	14	\$917.00
70402453-R	FDC-48L	48" warmer 240V Remote Infinite	1500	14	\$917.00
70400455	FDC-54L	54" warmer 208V Rocker	1500	16	\$1,023.00
70402455	FDC-54L	54" warmer 240V Rocker	1500	16	\$1,023.00
70400455-R	FDC-54L	54" warmer 208V Remote Infinite	1500	16	\$1,044.00
70402455-R	FDC-54L	54" warmer 240V Remote Infinite	1500	16	\$1,044.00
70400457	FDC-60L	60" warmer 208V Rocker	2000	18	\$1,034.00
70402457	FDC-60L	60" warmer 240V Rocker	2000	18	\$1,034.00
70400457-R	FDC-60L	60" warmer 208V Remote Infinite	2000	18	\$1,059.00
70402457-R	FDC-60L	60" warmer 240V Remote Infinite	2000	18	\$1,059.00
70400459	FDC-66L	66" warmer 208V Rocker	2000	20	\$1,124.00
70402459	FDC-66L	66" warmer 240V Rocker	2000	20	\$1,124.00
70400459-R	FDC-66L	66" warmer 208V Remote Infinite	2000	20	\$1,177.00
70402459-R	FDC-66L	66" warmer 240V Remote Infinite	2000	20	\$1,177.00
70400461	FDC-72L	72" warmer 208V Rocker	2000	22	\$1,188.00
70402461	FDC-72L	72" warmer 240V Rocker	2000	22	\$1,188.00
70400461-R	FDC-72L	72" warmer 208V Remote Infinite	2000	22	\$1,213.00
70402461-R	FDC-72L	72" warmer 240V Remote Infinite	2000	22	\$1,213.00

Overhead Warmer

SERIES

Lighted Single C*Radiant™ Overhead Warmers

Lighted Single Units are 9 1/8" wide and 2 1/2" high. (Side mounted box adds another 4 13/32" on width.) Side mounted and remote units come with a rocker control to control the heat and a rocker control to turn lights on and off (120v current). Add R for remote. If shipping via air freight, dimensional weights apply. Units come with 120 Watt Lights. Backed by APW's One Year Warranty. FOB Standex Dock, freight class 100. 60" and above must ship LTL.



Part Number	Model	Description	Watts	Weight (lbs)	Price
High Wattage					
70400464	FDLC-18H	18" single lighted warmer 120V Rocker	780	10	\$756.00
70401464	FDLC-18H	18" single lighted warmer 120/208V Rocker	780	10	\$756.00
70402464	FDLC-18H	18" single lighted warmer 120/240V Rocker	780	10	\$756.00
70400464-R	FDLC-18H	18" single lighted warmer 120V Remote Infinite	780	10	\$778.00
70401464-R	FDLC-18H	18" single lighted warmer 120/208V Remote Infinite	780	10	\$778.00
70402464-R	FDLC-18H	18" single lighted warmer 240V Remote Infinite	780	10	\$778.00
70400466	FDLC-24H	24" single lighted warmer 120V Rocker	880	11	\$771.00
70401466	FDLC-24H	24" single lighted warmer 120/208V Rocker	880	11	\$771.00
70402466	FDLC-24H	24" single lighted warmer 240V Rocker	880	11	\$771.00
70400466-R	FDLC-24H	24" single lighted warmer 120V Remote Infinite	880	11	\$797.00
70401466-R	FDLC-24H	24" single lighted warmer 120/208V Remote Infinite	880	11	\$797.00
70402466-R	FDLC-24H	24" single lighted warmer 240V Remote Infinite	880	11	\$797.00
70400468	FDLC-30H	30" single lighted warmer 120V Rocker	1230	13	\$921.00
70401468	FDLC-30H	30" single lighted warmer 120/208V Rocker	1230	13	\$921.00
70402468	FDLC-30H	30" single lighted warmer 240V Rocker	1230	13	\$921.00
70400468-R	FDLC-30H	30" single lighted warmer 120V Remote Infinite	1230	13	\$945.00
70401468-R	FDLC-30H	30" single lighted warmer 208V Remote Infinite	1230	13	\$945.00
70402468-R	FDLC-30H	30" single lighted warmer 240V Remote Infinite	1230	13	\$945.00
70400470	FDLC-36H	36" single lighted warmer 120V Rocker	1510	14	\$906.00
70401470	FDLC-36H	36" single lighted warmer 208V Rocker	1510	14	\$906.00
70402470	FDLC-36H	36" single lighted warmer 240V Rocker	1510	14	\$906.00
70400470-R	FDLC-36H	36" single lighted warmer 120V Remote Infinite	1510	14	\$988.00
70401470-R	FDLC-36H	36" single lighted warmer 120/208V Remote Infinite	1510	14	\$988.00
70402470-R	FDLC-36H	36" single lighted warmer 240V Remote Infinite	1510	14	\$988.00
70400472	FDLC-42H	42" single lighted warmer 120V Rocker	1600	16	\$1,118.00
70401472	FDLC-42H	42" single lighted warmer 208V Rocker	1600	16	\$1,118.00
70402472	FDLC-42H	42" single lighted warmer 240V Rocker	1600	16	\$1,118.00
70400472-R	FDLC-42H	42" single lighted warmer 120V Remote Infinite	1600	16	\$1,146.00
70401472-R	FDLC-42H	42" single lighted warmer 208V Remote Infinite	1600	16	\$1,146.00
70402472-R	FDLC-42H	42" single lighted warmer 240V Remote Infinite	1600	16	\$1,146.00
70400474	FDLC-48H	48" single lighted warmer 208V Rocker	2160	18	\$1,167.00
70402474	FDLC-48H	48" single lighted warmer 240V Rocker	2160	18	\$1,167.00
70400474-R	FDLC-48H	48" single lighted warmer 208V Remote Infinite	2160	18	\$1,188.00
70402474-R	FDLC-48H	48" single lighted warmer 240V Remote Infinite	2160	18	\$1,188.00
70400476	FDLC-54H	54" single lighted warmer 208V Rocker	2360	20	\$1,323.00
70402476	FDLC-54H	54" single lighted warmer 240V Rocker	2360	20	\$1,323.00
70400476-R	FDLC-54H	54" single lighted warmer 208V Remote Infinite	2360	20	\$1,349.00
70402476-R	FDLC-54H	54" single lighted warmer 240V Remote Infinite	2360	20	\$1,349.00
70402478	FDLC-60H	60" single lighted warmer 208V Rocker	2940	22	\$1,364.00
70400478	FDLC-60H	60" single lighted warmer 240V Rocker	2940	22	\$1,364.00
70402480	FDLC-66H	66" single lighted warmer 208V Rocker	2940	24	\$1,518.00
70400480	FDLC-66H	66" single lighted warmer 240V Rocker	2940	24	\$1,518.00
70400702	FDLC-72H	72" single lighted warmer 208V Rocker	3240	26	\$1,571.00
70400482	FDLC-72H	72" single lighted warmer 240V Rocker	3240	26	\$1,571.00

Continued on next page

Overhead Warmer

SERIES

Lighted Single C*Radiant™ Overhead Warmers *Continued*



Part Number	Model	Description	Watts	Weight (lbs)	Price
Standard Wattage					
70400463	FDLC-18L	18" single lighted warmer 120V Rocker	580	10	\$745.00
70401463	FDLC-18L	18" single lighted warmer 120/208V Rocker	580	10	\$745.00
70402463	FDLC-18L	18" single lighted warmer 240V Rocker	580	10	\$745.00
70400463-R	FDLC-18L	18" single lighted warmer 120V Remote Infinite	580	10	\$765.00
70401463-R	FDLC-18L	18" single lighted warmer 120/208V Remote Infinite	580	10	\$765.00
70402463-R	FDLC-18L	18" single lighted warmer 240V Remote Infinite	580	10	\$765.00
70400465	FDLC-24L	24" single lighted warmer 120V Rocker	780	11	\$760.00
70401465	FDLC-24L	24" single lighted warmer 120/208V Rocker	780	11	\$760.00
70402465	FDLC-24L	24" single lighted warmer 240V Rocker	780	11	\$760.00
70400465-R	FDLC-24L	24" single lighted warmer 120V Remote Infinite	780	11	\$786.00
70401465-R	FDLC-24L	24" single lighted warmer 120/208V Remote Infinite	780	11	\$786.00
70402465-R	FDLC-24L	24" single lighted warmer 240V Remote Infinite	780	11	\$786.00
70400467	FDLC-30L	30" single lighted warmer 120V Rocker	930	13	\$908.00
70401467	FDLC-30L	30" single lighted warmer 120/208V Rocker	930	13	\$908.00
70402467	FDLC-30L	30" single lighted warmer 120/240V Rocker	930	13	\$908.00
70400467-R	FDLC-30L	30" single lighted warmer 120V Remote Infinite	930	13	\$934.00
70401467-R	FDLC-30L	30" single lighted warmer 120/208V Remote Infinite	930	13	\$934.00
70402467-R	FDLC-30L	30" single lighted warmer 120/240V Remote Infinite	930	13	\$934.00
70400469	FDLC-36L	36" single lighted warmer 120V Rocker	1160	14	\$952.00
70401469	FDLC-36L	36" single lighted warmer 208V Rocker	1160	14	\$952.00
70402469	FDLC-36L	36" single lighted warmer 240V Rocker	1160	14	\$952.00
70400469-R	FDLC-36L	36" single lighted warmer 120V Remote Infinite	1160	14	\$980.00
7041469-R	FDLC-36L	36" single lighted warmer 208V Remote Infinite	1160	14	\$980.00
70402469-R	FDLC-36L	36" single lighted warmer 240V Remote Infinite	1160	14	\$980.00
70400471	FDLC-42L	42" single lighted warmer 120V Rocker	1360	16	\$1,110.00
70401471	FDLC-42L	42" single lighted warmer 208V Rocker	1360	16	\$1,110.00
70402471	FDLC-42L	42" single lighted warmer 240V Rocker	1360	16	\$1,110.00
70400471-R	FDLC-42L	42" single lighted warmer 120V Remote Infinite	1360	16	\$1,131.00
70401471-R	FDLC-42L	42" single lighted warmer 208V Remote Infinite	1360	16	\$1,131.00
70402471-R	FDLC-42L	42" single lighted warmer 240V Remote Infinite	1360	16	\$1,131.00
70400473	FDLC-48L	48" single lighted warmer 120V Rocker	1660	18	\$1,158.00
70401473	FDLC-48L	48" single lighted warmer 208V Rocker	1660	18	\$1,158.00
70402473	FDLC-48L	48" single lighted warmer 240V Rocker	1660	18	\$1,158.00
70400473-R	FDLC-48L	48" single lighted warmer 120V Remote Infinite	1660	18	\$1,177.00
70401473-R	FDLC-48L	48" single lighted warmer 208V Remote Infinite	1660	18	\$1,177.00
70402473-R	FDLC-48L	48" single lighted warmer 240V Remote Infinite	1660	18	\$1,177.00
70400475	FDLC-54L	54" single lighted warmer 208V Rocker	1660	20	\$1,309.00
70402475	FDLC-54L	54" single lighted warmer 240V Rocker	1660	20	\$1,309.00
70400475-R	FDLC-54L	54" single lighted warmer 208V Remote Infinite	1660	20	\$1,334.00
70402475-R	FDLC-54L	54" single lighted warmer 240V Remote Infinite	1660	20	\$1,334.00
70400477	FDLC-60L	60" single lighted warmer 208V Rocker	2240	22	\$1,354.00
70402477	FDLC-60L	60" single lighted warmer 240V Rocker	2240	22	\$1,354.00
70400477-R	FDLC-60L	60" single lighted warmer 208V Remote Infinite	2240	22	\$1,376.00
70402477-R	FDLC-60L	60" single lighted warmer 240V Remote Infinite	2240	22	\$1,376.00
70400479	FDLC-66L	66" single lighted warmer 208V Rocker	2240	24	\$1,511.00
70402479	FDLC-66L	66" single lighted warmer 240V Rocker	2240	24	\$1,511.00
70400479-R	FDLC-66L	66" single lighted warmer 208V Remote Infinite	2240	24	\$1,530.00
70402479-R	FDLC-66L	66" single lighted warmer 240V Remote Infinite	2240	24	\$1,530.00
70400481	FDLC-72L	72" single lighted warmer 208V Rocker	2240	26	\$1,561.00
70402481	FDLC-72L	72" single lighted warmer 240V Rocker	2240	26	\$1,561.00
70400481-R	FDLC-72L	72" single lighted warmer 208V Remote Infinite	2240	26	\$1,587.00
70402481-R	FDLC-72L	72" single lighted warmer 240V Remote Infinite	2240	26	\$1,587.00

Overhead Warmer

SERIES

Double C*Radiant™ Overhead Warmers

Double Units are 15 1/8" wide and 2 1/2" high. (Side Mounted box adds another 4 13/32" on width) Add R for remote control box.

Remote boxes are recommended for all doubles mounted 20"-24" from non-flammable surface. If shipping via air freight, dimensional weights apply. Backed by APW's One Year Warranty. FOB Standex Dock, freight class 100. 60" and above must ship LTL.



Part Number	Model	Description	Watts	Weight (lbs)	Price
High Wattage					
70400484	FDDC-18H	18" dual warmer 120V Rocker	1400	12	\$1,250.00
70401484	FDDC-18H	18" dual warmer 208V Rocker	1400	12	\$1,250.00
70402484	FDDC-18H	18" dual warmer 240V Rocker	1400	12	\$1,250.00
70400484-R	FDDC-18H	18" dual warmer 120V Remote Infinite	1400	12	\$1,365.00
70401484-R	FDDC-18H	18" dual warmer 208V Remote Infinite	1400	12	\$1,365.00
70402484-R	FDDC-18H	18" dual warmer 240V Remote Infinite	1400	12	\$1,365.00
70400486	FDDC-24H	24" dual warmer 120V Rocker	1600	16	\$1,303.00
70401486	FDDC-24H	24" dual warmer 208V Rocker	1600	16	\$1,303.00
70402486	FDDC-24H	24" dual warmer 240V Rocker	1600	16	\$1,303.00
70400486-R	FDDC-24H	24" dual warmer 120V Remote Infinite	1600	16	\$1,329.00
70401486-R	FDDC-24H	24" dual warmer 208V Remote Infinite	1600	16	\$1,329.00
70402486-R	FDDC-24H	24" dual warmer 240V Remote Infinite	1600	16	\$1,329.00
70401488	FDDC-30H	30" dual warmer 120V Rocker	2300	18	\$1,589.00
70400488	FDDC-30H	30" dual warmer 208V Rocker	2300	18	\$1,589.00
70402488	FDDC-30H	30" dual warmer 240V Rocker	2300	18	\$1,589.00
70401488-R	FDDC-30H	30" dual warmer 120V Remote Infinite	2300	18	\$1,616.00
70400488-R	FDDC-30H	30" dual warmer 208V Remote Infinite	2300	18	\$1,616.00
70402488-R	FDDC-30H	30" dual warmer 240V Remote Infinite	2300	18	\$1,616.00
70401490	FDDC-36H	36" dual warmer 120V Rocker	2700	21	\$1,642.00
70400490	FDDC-36H	36" dual warmer 208V Rocker	2700	21	\$1,642.00
70402490	FDDC-36H	36" dual warmer 240V Rocker	2700	21	\$1,642.00
70401490-R	FDDC-36H	36" dual warmer 120V Remote Infinite	2700	21	\$1,666.00
70400490-R	FDDC-36H	36" dual warmer 208V Remote Infinite	2700	21	\$1,666.00
70402490-R	FDDC-36H	36" dual warmer 240V Remote Infinite	2700	21	\$1,666.00
70400492	FDDC-42H	42" dual warmer 208V Rocker	3000	24	\$1,910.00
70402492	FDDC-42H	42" dual warmer 240V Rocker	3000	24	\$1,910.00
70400492-R	FDDC-42H	42" dual warmer 208V Remote Infinite	3000	24	\$1,939.00
70402492-R	FDDC-42H	42" dual warmer 240V Remote Infinite	3000	24	\$1,939.00
70400494	FDDC-48H	48" dual warmer 208V Rocker	4000	25	\$1,964.00
70402494	FDDC-48H	48" dual warmer 240V Rocker	4000	25	\$1,964.00
70400494-R	FDDC-48H	48" dual warmer 208V Remote Infinite	4000	25	\$1,990.00
70402494-R	FDDC-48H	48" dual warmer 240V Remote Infinite	4000	25	\$1,990.00
70400496	FDDC-54H	54" dual warmer 208V Rocker	4400	28	\$2,265.00
70402496	FDDC-54H	54" dual warmer 240V Rocker	4400	28	\$2,265.00
70400496-R	FDDC-54H	54" dual warmer 208V Remote Infinite	4400	28	\$2,274.00
70402496-R	FDDC-54H	54" dual warmer 240V Remote Infinite	4400	28	\$2,274.00
70400498	FDDC-60H	60" dual warmer 208V Rocker	5400	30	\$2,306.00
70402498	FDDC-60H	60" dual warmer 240V Rocker	5400	30	\$2,306.00
70400500	FDDC-66H	66" dual warmer 208V Rocker	5400	34	\$2,574.00
70402500	FDDC-66H	66" dual warmer 240V Rocker	5400	34	\$2,574.00
70402502	FDDC-72H	72" dual warmer 208V Rocker	6000	36	\$2,675.00
70400502	FDDC-72H	72" dual warmer 240V Rocker	6000	36	\$2,675.00

Continued on next page

Overhead Warmer

SERIES

Double C*Radiant™ Overhead Warmers *Continued*



Part Number	Model	Description	Watts	Weight (lbs)	\$2,248
Standard Wattage					
70400483	FDDC-18L	18" dual warmer 120V Rocker	1000	12	\$1,243.00
70401483	FDDC-18L	18" dual warmer 208V Rocker	1000	12	\$1,243.00
70402483	FDDC-18L	18" dual warmer 240V Rocker	1000	12	\$1,243.00
70400483-R	FDDC-18L	18" dual warmer 120V Remote Infinite	1000	12	\$1,264.00
70401483-R	FDDC-18L	18" dual warmer 208V Remote Infinite	1000	12	\$1,264.00
70402483-R	FDDC-18L	18" dual warmer 240V Remote Infinite	1000	12	\$1,264.00
70400485	FDDC-24L	24" dual warmer 120V Rocker	1400	16	\$1,296.00
70401485	FDDC-24L	24" dual warmer 208V Rocker	1400	16	\$1,296.00
70402485	FDDC-24L	24" dual warmer 240V Rocker	1400	16	\$1,296.00
70400485-R	FDDC-24L	24" dual warmer 120V Remote Infinite	1400	16	\$1,318.00
70401485-R	FDDC-24L	24" dual warmer 208V Remote Infinite	1400	16	\$1,318.00
70402485-R	FDDC-24L	24" dual warmer 240V Remote Infinite	1400	16	\$1,318.00
70400487	FDDC-30L	30" dual warmer 120V Rocker	1700	18	\$1,580.00
70401487	FDDC-30L	30" dual warmer 208V Rocker	1700	18	\$1,580.00
70402487	FDDC-30L	30" dual warmer 240V Rocker	1700	18	\$1,580.00
70400487-R	FDDC-30L	30" dual warmer 120V Remote Infinite	1700	18	\$1,605.00
70401487-R	FDDC-30L	30" dual warmer 208V Remote Infinite	1700	18	\$1,605.00
70402487-R	FDDC-30L	30" dual warmer 240V Remote Infinite	1700	18	\$1,605.00
70401489	FDDC-36L	36" dual warmer 120V Rocker	2000	22	\$1,634.00
70400489	FDDC-36L	36" dual warmer 208V Rocker	2000	22	\$1,634.00
70402489	FDDC-36L	36" dual warmer 240V Rocker	2000	22	\$1,634.00
70401489-R	FDDC-36L	36" dual warmer 120V Remote Infinite	2000	22	\$1,652.00
70400489-R	FDDC-36L	36" dual warmer 208V Remote Infinite	2000	22	\$1,652.00
70402489-R	FDDC-36L	36" dual warmer 240V Remote Infinite	2000	22	\$1,652.00
70401491	FDDC-42L	42" dual warmer 120V Rocker	2400	24	\$1,901.00
70400491	FDDC-42L	42" dual warmer 208V Rocker	2400	24	\$1,901.00
70402491	FDDC-42L	42" dual warmer 240V Rocker	2400	24	\$1,901.00
70401491-R	FDDC-42L	42" dual warmer 120V Remote Infinite	2400	24	\$1,928.00
70400491-R	FDDC-42L	42" dual warmer 208V Remote Infinite	2400	24	\$1,928.00
70402491-R	FDDC-42L	42" dual warmer 240V Remote Infinite	2400	24	\$1,928.00
70401493	FDDC-48L	48" dual warmer 120V Rocker	3000	24	\$1,956.00
70400493	FDDC-48L	48" dual warmer 208V Rocker	3000	24	\$1,956.00
70402493	FDDC-48L	48" dual warmer 240V Rocker	3000	24	\$1,956.00
70401493-R	FDDC-48L	48" dual warmer 120V Remote Infinite	3000	24	\$1,978.00
70400493-R	FDDC-48L	48" dual warmer 208V Remote Infinite	3000	24	\$1,978.00
70402493-R	FDDC-48L	48" dual warmer 240V Remote Infinite	3000	24	\$1,978.00
70400495	FDDC-54L	54" dual warmer 208V Rocker	3000	28	\$2,240.00
70402495	FDDC-54L	54" dual warmer 240V Rocker	3000	28	\$2,240.00
70400495-R	FDDC-54L	54" dual warmer 208V Remote Infinite	3000	28	\$2,264.00
70402495-R	FDDC-54L	54" dual warmer 240V Remote Infinite	3000	28	\$2,264.00
70400497	FDDC-60L	60" dual warmer 208V Rocker	4000	30	\$2,295.00
70402497	FDDC-60L	60" dual warmer 240V Rocker	4000	30	\$2,295.00
70400497-R	FDDC-60L	60" dual warmer 208V Remote Infinite	4000	30	\$2,315.00
70402497-R	FDDC-60L	60" dual warmer 240V Remote Infinite	4000	30	\$2,315.00
70400499	FDDC-66L	66" dual warmer 208V Rocker	4000	34	\$2,566.00
70402499	FDDC-66L	66" dual warmer 240V Rocker	4000	34	\$2,566.00
70400499-R	FDDC-66L	66" dual warmer 208V Remote Infinite	4000	34	\$2,587.00
70402499-R	FDDC-66L	66" dual warmer 240V Remote Infinite	4000	34	\$2,587.00
70400501	FDDC-72L	72" dual warmer 208V Rocker	4000	36	\$2,666.00
70402501	FDDC-72L	72" dual warmer 240V Rocker	4000	36	\$2,666.00
70400501-R	FDDC-72L	72" dual warmer 208V Remote Infinite	4000	36	\$2,694.00
70402501-R	FDDC-72L	72" dual warmer 240V Remote Infinite	4000	36	\$2,694.00

Overhead Warmer

SERIES

Lighted Double C*Radiant™ Overhead Warmers

Double Units are 15 1/8" wide and 2 1/2" high. Remote control box is recommended for all double lighted units mounted 20-24" from non-flammable surface. Remote has toggle for heat and toggle for light. Units come with 120 Watt Lights. If shipping via air freight, dimensional weights apply. Backed by APW's One Year Warranty. FOB Standex Dock, freight class 100. 60" and above must ship LTL.



Part Number	Model	Description	Watts	Weight (lbs)	Price
High Wattage					
70400504	FDDL-18H	18" dual lighted warmer 120V Rocker	1480	13	\$1,296.00
70401504	FDDL-18H	18" dual lighted warmer 208V Rocker	1480	13	\$1,296.00
70402504	FDDL-18H	18" dual lighted warmer 240V Rocker	1480	13	\$1,296.00
70400504-R	FDDL-18H	18" dual lighted warmer 120V Remote Infinite	1480	13	\$1,318.00
70401504-R	FDDL-18H	18" dual lighted warmer 208V Remote Infinite	1480	13	\$1,318.00
70402504-R	FDDL-18H	18" dual lighted warmer 240V Remote Infinite	1480	13	\$1,318.00
70400506	FDDL-24H	24" dual lighted warmer 120V Rocker	1680	17	\$1,349.00
70401506	FDDL-24H	24" dual lighted warmer 208V Rocker	1680	17	\$1,349.00
70402506	FDDL-24H	24" dual lighted warmer 240V Rocker	1680	17	\$1,349.00
70400506-R	FDDL-24H	24" dual lighted warmer 120V Remote Infinite	1680	17	\$1,372.00
70401506-R	FDDL-24H	24" dual lighted warmer 208V Remote Infinite	1680	17	\$1,372.00
70402506-R	FDDL-24H	24" dual lighted warmer 240V Remote Infinite	1680	17	\$1,372.00
70400508	FDDL-30H	30" dual lighted warmer 120V Rocker	2380	19	\$1,636.00
70401508	FDDL-30H	30" dual lighted warmer 208V Rocker	2380	19	\$1,636.00
70402508	FDDL-30H	30" dual lighted warmer 240V Rocker	2380	19	\$1,636.00
70401508-R	FDDL-30H	30" dual lighted warmer 120V Remote Infinite	2380	19	\$1,655.00
70400508-R	FDDL-30H	30" dual lighted warmer 208V Remote Infinite	2860	19	\$1,655.00
70402508-R	FDDL-30H	30" dual lighted warmer 240V Remote Infinite	2860	19	\$1,655.00
70401510	FDDL-36H	36" dual lighted warmer 120V Rocker	2860	22	\$1,690.00
70400510	FDDL-36H	36" dual lighted warmer 208V Rocker	2860	22	\$1,690.00
70402510	FDDL-36H	36" dual lighted warmer 240V Rocker	2860	22	\$1,690.00
70401510-R	FDDL-36H	36" dual lighted warmer 120V Remote Infinite	2860	22	\$1,711.00
70400510-R	FDDL-36H	36" dual lighted warmer 208V Remote Infinite	2860	22	\$1,711.00
70402510-R	FDDL-36H	36" dual lighted warmer 240V Remote Infinite	2860	22	\$1,711.00
70401512	FDDL-42H	42" dual lighted warmer 1 208V Rocker	3160	25	\$1,956.00
70402512	FDDL-42H	42" dual lighted warmer 240V Rocker	3160	25	\$1,956.00
70401512-R	FDDL-42H	42" dual lighted warmer 208V Remote Infinite	3160	25	\$1,978.00
70402512-R	FDDL-42H	42" dual lighted warmer 240V Remote Infinite	3160	25	\$1,978.00
70400514	FDDL-48H	48" dual lighted warmer 208V Rocker	4160	26	\$2,004.00
70402514	FDDL-48H	48" dual lighted warmer 240V Rocker	4160	26	\$2,004.00
70400514-R	FDDL-48H	48" dual lighted warmer 208V Remote Infinite	4160	26	\$2,033.00
70402514-R	FDDL-48H	48" dual lighted warmer 240V Remote Infinite	4160	26	\$2,033.00
70400516	FDDL-54H	54" dual lighted warmer 208V Rocker	4560	29	\$2,298.00
70402516	FDDL-54H	54" dual lighted warmer 240V Rocker	4560	29	\$2,298.00
70400516-R	FDDL-54H	54" dual lighted warmer 208V Remote Infinite	4560	29	\$2,320.00
70402516-R	FDDL-54H	54" dual lighted warmer 240V Remote Infinite	4560	29	\$2,320.00
70402518	FDDL-60H	60" dual lighted warmer 208V Rocker	5640	31	\$2,346.00
70400518	FDDL-60H	60" dual lighted warmer 240V Rocker	5640	31	\$2,346.00
70402520	FDDL-66H	66" dual lighted warmer 120/208V Rocker	5640	35	\$2,612.00
70400520	FDDL-66H	66" dual lighted warmer 120/240V Rocker	5640	35	\$2,612.00
70402522	FDDL-72H	72" dual lighted warmer 208V Rocker	6240	37	\$2,720.00
70400522	FDDL-72H	72" dual lighted warmer 240V Rocker	6240	37	\$2,720.00

Continued on next page

Overhead Warmer

SERIES

Lighted Double C*Radiant™ Overhead Warmers *Continued*



Part Number	Model	Description	Watts	Weight (lbs)	Price
Standard Wattage					
70400503	FDDL-18L	18" dual lighted warmer 120V Rocker	1080	13	\$1,285.00
70401503	FDDL-18L	18" dual lighted warmer 208V Rocker	1080	13	\$1,285.00
70402503	FDDL-18L	18" dual lighted warmer 240V Rocker	1080	13	\$1,285.00
70400503-R	FDDL-18L	18" dual lighted warmer 120V Remote Infinite	1080	13	\$1,306.00
70401503-R	FDDL-18L	18" dual lighted warmer 208V Remote Infinite	1080	13	\$1,306.00
70402503-R	FDDL-18L	18" dual lighted warmer 240V Remote Infinite	1080	13	\$1,306.00
70400505	FDDL-24L	24" dual lighted warmer 120V Rocker	1480	17	\$1,334.00
70401505	FDDL-24L	24" dual lighted warmer 208V Rocker	1480	17	\$1,334.00
70402505	FDDL-24L	24" dual lighted warmer 240V Rocker	1480	17	\$1,334.00
70400505-R	FDDL-24L	24" dual lighted warmer 120V Remote Infinite	1480	17	\$1,360.00
70401505-R	FDDL-24L	24" dual lighted warmer 208V Remote Infinite	1480	17	\$1,360.00
70402505-R	FDDL-24L	24" dual lighted warmer 240V Remote Infinite	1480	17	\$1,360.00
70400507	FDDL-30L	30" dual lighted warmer 120V Rocker	1780	19	\$1,623.00
70401507	FDDL-30L	30" dual lighted warmer 208V Rocker	1780	19	\$1,623.00
70402507	FDDL-30L	30" dual lighted warmer 240V Rocker	1780	19	\$1,623.00
70400507-R	FDDL-30L	30" dual lighted warmer 120V Remote Infinite	1780	19	\$1,647.00
70401507-R	FDDL-30L	30" dual lighted warmer 208V Remote Infinite	1780	19	\$1,647.00
70402507-R	FDDL-30L	30" dual lighted warmer 240V Remote Infinite	1780	19	\$1,647.00
70401509	FDDL-36L	36" dual lighted warmer 120V Rocker	2160	22	\$1,678.00
70400509	FDDL-36L	36" dual lighted warmer 208V Rocker	2160	22	\$1,678.00
70402509	FDDL-36L	36" dual lighted warmer 240V Rocker	2160	22	\$1,678.00
70401509-R	FDDL-36L	36" dual lighted warmer 120V Remote Infinite	2160	22	\$1,700.00
70400509-R	FDDL-36L	36" dual lighted warmer 208V Remote Infinite	2160	22	\$1,700.00
70402509-R	FDDL-36L	36" dual lighted warmer 240V Remote Infinite	2160	22	\$1,700.00
70400511	FDDL-42L	42" dual lighted warmer 120V Rocker	2560	25	\$1,944.00
70401511	FDDL-42L	42" dual lighted warmer 208V Rocker	2560	25	\$1,944.00
70402511	FDDL-42L	42" dual lighted warmer 240V Rocker	2560	25	\$1,944.00
70400511-R	FDDL-42L	42" dual lighted warmer 120V Remote Infinite	2560	25	\$1,967.00
70401511-R	FDDL-42L	42" dual lighted warmer 208V Remote Infinite	2560	25	\$1,967.00
70402511-R	FDDL-42L	42" dual lighted warmer 240V Remote Infinite	2560	25	\$1,967.00
70401513	FDDL-48L	48" dual lighted warmer 120V Rocker	3160	26	\$1,955.00
70400513	FDDL-48L	48" dual lighted warmer 208V Rocker	3160	26	\$1,955.00
70402513	FDDL-48L	48" dual lighted warmer 240V Rocker	3160	26	\$1,955.00
70401513-R	FDDL-48L	48" dual lighted warmer 120V Remote Infinite	3160	26	\$2,021.00
70400513-R	FDDL-48L	48" dual lighted warmer 208V Remote Infinite	3160	26	\$2,021.00
70402513-R	FDDL-48L	48" dual lighted warmer 240V Remote Infinite	3160	26	\$2,021.00
70400515	FDDL-54L	54" dual lighted warmer 208V Rocker	3160	29	\$2,284.00
70402515	FDDL-54L	54" dual lighted warmer 240V Rocker	3160	29	\$2,284.00
70400515-R	FDDL-54L	54" dual lighted warmer 208V Remote Infinite	3160	29	\$2,310.00
70402515-R	FDDL-54L	54" dual lighted warmer 240V Remote Infinite	3160	29	\$2,310.00
70400517	FDDL-60L	60" dual lighted warmer 208V Rocker	4240	31	\$2,336.00
70402517	FDDL-60L	60" dual lighted warmer 240V Rocker	4240	31	\$2,336.00
70400517-R	FDDL-60L	60" dual lighted warmer 208V Remote Infinite	4240	31	\$2,365.00
70402517-R	FDDL-60L	60" dual lighted warmer 240V Remote Infinite	4240	31	\$2,365.00
70400519	FDDL-66L	66" dual lighted warmer 208V Rocker	4240	35	\$2,604.00
70402519	FDDL-66L	66" dual lighted warmer 240V Rocker	4240	35	\$2,604.00
70400519-R	FDDL-66L	66" dual lighted warmer 208V Remote Infinite	4240	35	\$2,632.00
70402519-R	FDDL-66L	66" dual lighted warmer 240V Remote Infinite	4240	35	\$2,632.00
70400521	FDDL-72L	72" dual lighted warmer 208V Rocker	4240	37	\$2,711.00
70402521	FDDL-72L	72" dual lighted warmer 240V Rocker	4240	37	\$2,711.00
70400521-R	FDDL-72L	72" dual lighted warmer 208V Remote Infinite	4240	37	\$2,735.00
70402521-R	FDDL-72L	72" dual lighted warmer 240V Remote Infinite	4240	37	\$2,735.00

Overhead Warmer

SERIES

Single Standard Calrod Overhead Warmers

Overhead Warmers come in Standard Energy Efficient Wattage and High Performance High Heat Wattage. These Overhead Warmers are made with special "mirror finished" stainless steel reflectors that generate over 22% more heat. Pilot lights, toggle switch and mounting brackets come standard. Infinite control available for maximum temperature management. Specify 120V, 208V, or 240V. Models FD-48 through 72 are available only in 208V and 240V. Single units are 6" wide and 2 1/2" high. Add -T for Toggle or -I for Infinite Controls. For Remote, add "R" to the end of model number. For attached cord and plug, add CS after model number. Full two year warranty on elements. If shipping via air freight, dimensional weights apply. Backed by APW's Two Year Parts and One Year Labor Warranty. FOB Standex Dock, freight class 100. 60" and above must ship LTL.



Part Number	Model	Description	Watts	Weight (lbs)	Price
High Performance, Fast Recovery					
OH18H1T	FD-18H *	18" Warmer Toggle 120V	400	7	\$254.00
OH18H2T	FD-18H *	18" Warmer Toggle 208V	400	7	\$254.00
OH18H1I	FD-18H *	18" Warmer Infinite 120V	400	7	\$296.00
OH18H2I	FD-18H *	18" Warmer Infinite 208V	400	7	\$296.00
OH24H1T	FD-24H *	24" Warmer Toggle 120V	575	7	\$273.00
OH24H2T	FD-24H *	24" Warmer Toggle 208V	575	7	\$273.00
OH24H3T	FD-24H *	24" Warmer Toggle 240V	575	7	\$273.00
OH24H1I	FD-24H *	24" Warmer Infinite 120V	575	7	\$317.00
OH24H2I	FD-24H *	24" Warmer Infinite 208V	575	7	\$317.00
OH24H3I	FD-24H *	24" Warmer Infinite 240V	575	7	\$317.00
OH30H1T	FD-30H *	30" Warmer Toggle 120V	760	8	\$283.00
OH30H2T	FD-30H *	30" Warmer Toggle 208V	760	8	\$283.00
OH30H3T	FD-30H *	30" Warmer Toggle 240V	760	8	\$283.00
OH30H1I	FD-30H *	30" Warmer Infinite 120V	760	8	\$332.00
OH30H2I	FD-30H *	30" Warmer Infinite 208V	760	8	\$332.00
OH30H3I	FD-30H *	30" Warmer Infinite 240V	760	8	\$332.00
OH36H1T	FD-36H *	36" Warmer Toggle 120V	920	9	\$303.00
OH36H2T	FD-36H *	36" Warmer Toggle 208V	920	9	\$303.00
OH36H3T	FD-36H *	36" Warmer Toggle 240V	920	9	\$303.00
OH36H1I	FD-36H *	36" Warmer Infinite 120V	920	9	\$355.00
OH36H2I	FD-36H *	36" Warmer Infinite 208V	920	9	\$355.00
OH36H3I	FD-36H *	36" Warmer Infinite 240V	920	9	\$355.00
OH42H1T	FD-42H	42" Warmer Toggle 120V	1100	11	\$324.00
OH42H2T	FD-42H	42" Warmer Toggle 208V	1100	11	\$324.00
OH42H3T	FD-42H	42" Warmer Toggle 240V	1100	11	\$324.00
OH42H1I	FD-42H	42" Warmer Infinite 120V	1100	11	\$371.00
OH42H2I	FD-42H	42" Warmer Infinite 208V	1100	11	\$371.00
OH42H3I	FD-42H	42" Warmer Infinite 240V	1100	11	\$371.00
OH48H1T	FD-48H *	48" Warmer Toggle 120V	1265	12	\$338.00
OH48H2T	FD-48H *	48" Warmer Toggle 208V	1265	12	\$338.00
OH48H3T	FD-48H *	48" Warmer Toggle 240V	1265	12	\$338.00
OH48H1I	FD-48H *	48" Warmer Infinite 120V	1265	12	\$391.00
OH48H2I	FD-48H *	48" Warmer Infinite 208V	1265	12	\$391.00
OH48H3I	FD-48H *	48" Warmer Infinite 240V	1265	12	\$391.00
OH54H1T	FD-54H	54" Warmer Toggle 120V	1425	13	\$354.00
OH54H2T	FD-54H	54" Warmer Toggle 208V	1425	13	\$354.00
OH54H3T	FD-54H	54" Warmer Toggle 240V	1425	13	\$354.00
OH54H1I	FD-54H	54" Warmer Infinite 120V	1425	13	\$409.00
OH54H2I	FD-54H	54" Warmer Infinite 208V	1425	13	\$409.00
OH54H3I	FD-54H	54" Warmer Infinite 240V	1425	13	\$409.00
OH60H1T	FD-60H *	60" Warmer Toggle 120V	1610	14	\$390.00
OH60H2T	FD-60H *	60" Warmer Toggle 208V	1610	14	\$390.00
OH60H3T	FD-60H *	60" Warmer Toggle 240V	1610	14	\$390.00
OH60H1I	FD-60H *	60" Warmer Infinite 120V	1610	14	\$443.00
OH60H2I	FD-60H *	60" Warmer Infinite 208V	1610	14	\$443.00
OH60H3I	FD-60H *	60" Warmer Infinite 240V	1610	14	\$443.00
OH66H2T	FD-66H	66" Warmer Toggle 208V	1800	16	\$416.00
OH66H3T	FD-66H	66" Warmer Toggle 240V	1800	16	\$416.00
OH66H2I	FD-66H	66" Warmer Infinite 208V	1800	16	\$485.00
OH66H3I	FD-66H	66" Warmer Infinite 240V	1800	16	\$485.00
OH72H2T	FD-72H *	72" Warmer Toggle 208V	1980	17	\$473.00
OH72H3T	FD-72H *	72" Warmer Toggle 240V	1980	17	\$473.00
OH72H2I	FD-72H *	72" Warmer Infinite 208V	1980	17	\$524.00
OH72H3I	FD-72H *	72" Warmer Infinite 240V	1980	17	\$524.00

* These models CSA approved
Remote units use toggle price.

Continued on next page

Overhead Warmer

SERIES

Single Standard Calrod Overhead Warmers *Continued*



Part Number	Model	Description	Watts	Weight (lbs)	Price
Energy Efficient					
OH18L1T	FD-18L *	18" Warmer Toggle 120V	250	5	\$248.00
OH18L2T	FD-18L *	18" Warmer Toggle 208V	250	5	\$248.00
OH18L3T	FD-18L *	18" Warmer Toggle 240V	250	5	\$248.00
OH18L1I	FD-18L *	18" Warmer Infinite 120V	250	5	\$290.00
OH18L2I	FD-18L *	18" Warmer Infinite 208V	250	5	\$290.00
OH18L3I	FD-18L *	18" Warmer Infinite 240V	250	5	\$290.00
OH24L1T	FD-24L *	24" Warmer Toggle 120V	350	7	\$263.00
OH24L2T	FD-24L *	24" Warmer Toggle 208V	350	7	\$263.00
OH24L3T	FD-24L *	24" Warmer Toggle 240V	350	7	\$263.00
OH24L1I	FD-24L *	24" Warmer Infinite 120V	350	7	\$311.00
OH24L2I	FD-24L *	24" Warmer Infinite 208V	350	7	\$311.00
OH24L3I	FD-24L *	24" Warmer Infinite 240V	350	7	\$311.00
OH30L1T	FD-30L *	30" Warmer Toggle 120V	450	8	\$275.00
OH30L3T	FD-30L *	30" Warmer Toggle 240V	450	8	\$275.00
OH30L1I	FD-30L *	30" Warmer Infinite 120V	450	8	\$319.00
OH30L3I	FD-30L *	30" Warmer Infinite 208V	450	8	\$319.00
OH36L1T	FD-36L *	36" Warmer Toggle 120V	575	9	\$299.00
OH36L2T	FD-36L *	36" Warmer Toggle 208V	575	9	\$299.00
OH36L3T	FD-36L *	36" Warmer Toggle 240V	575	9	\$299.00
OH36L1I	FD-36L *	36" Warmer Infinite 120V	575	9	\$350.00
OH36L2I	FD-36L *	36" Warmer Infinite 208V	575	9	\$350.00
OH42L1T	FD-42L	42" Warmer Toggle 120V	675	11	\$314.00
OH42L2T	FD-42L	42" Warmer Toggle 208V	675	11	\$314.00
OH42L3T	FD-42L	42" Warmer Toggle 240V	675	11	\$314.00
OH42L1I	FD-42L	42" Warmer Infinite 120V	675	11	\$367.00
OH42L2I	FD-42L	42" Warmer Infinite 208V	675	11	\$367.00
OH42L3I	FD-42L	42" Warmer Infinite 240V	675	11	\$367.00
OH48L1T	FD-48L	48" Warmer Toggle 120V	800	12	\$313.00
OH48L2T	FD-48L	48" Warmer Toggle 208V	800	12	\$313.00
OH48L3T	FD-48L	48" Warmer Toggle 240V	800	12	\$313.00
OH48L1I	FD-48L	48" Warmer Infinite 120V	800	12	\$381.00
OH48L2I	FD-48L	48" Warmer Infinite 208V	800	12	\$381.00
OH48L3I	FD-48L	48" Warmer Infinite 240V	800	12	\$381.00
OH54L1T	FD-54L	54" Warmer Toggle 120V	925	13	\$329.00
OH54L2T	FD-54L	54" Warmer Toggle 208V	925	13	\$329.00
OH54L3T	FD-54L	54" Warmer Toggle 240V	925	13	\$329.00
OH54L1I	FD-54L	54" Warmer Infinite 120V	925	13	\$405.00
OH54L2I	FD-54L	54" Warmer Infinite 208V	925	13	\$405.00
OH54L3I	FD-54L	54" Warmer Infinite 240V	925	13	\$405.00
OH60L1T	FD-60L *	60" Warmer Toggle 120V	1050	14	\$377.00
OH60L2T	FD-60L *	60" Warmer Toggle 208V	1050	14	\$377.00
OH60L3T	FD-60L *	60" Warmer Toggle 240V	1050	14	\$377.00
OH60L1I	FD-60L *	60" Warmer Infinite 120V	1050	14	\$438.00
OH60L2I	FD-60L *	60" Warmer Infinite 208V	1050	14	\$438.00
OH60L3I	FD-60L *	60" Warmer Infinite 240V	1050	14	\$438.00
OH66L3T	FD-66L *	66" Warmer Toggle 240V	1160	16	\$407.00
OH66L3I	FD-66L *	66" Warmer Infinite 240V	1160	16	\$483.00
OH72L2T	FD-72L *	72" Warmer Toggle 208V	1275	17	\$475.00
OH72L3T	FD-72L *	72" Warmer Toggle 240V	1275	17	\$475.00
OH72L2I	FD-72L *	72" Warmer Infinite 208V	1275	17	\$519.00
OH72L3I	FD-72L *	72" Warmer Infinite 240V	1275	17	\$519.00

* These models CSA approved
Remote units use toggle price.

Overhead Warmer

SERIES

Lighted Single Standard Calrod Overhead Warmers

Single units are 9" wide and 2 1/2" high. Add -T for Toggle or -I for Infinite Controls. See mounting instructions on page 38. Remote control boxes are recommended (Add R). 18" to 48" available in 120V, 208V, or 240V. 54-60" available in 208V or 240V. Note: Unit and Light are the same voltage. Backed by APW's Two Year Parts and One Year Labor Warranty. FOB Standex Dock, freight class 100. 60" and above must ship LTL.



Part Number	Model	Description	Watts	Weight (lbs)	Price
High Performance, Fast Recovery					
OHL18H1T	FDL-18H *	18" Lighted Warmer Toggle 120V	480	7	\$408.00
OHL18H2T	FDL-18H *	18" Lighted Warmer Toggle 208V	480	7	\$408.00
OHL18H1I	FDL-18H *	18" Lighted Warmer Infinite 120V	480	7	\$475.00
OHL18H2I	FDL-18H *	18" Lighted Warmer Infinite 208V	480	7	\$475.00
OHL24H1T	FDL-24H *	24" Lighted Warmer Toggle 120V	480	7	\$433.00
OHL24H2T	FDL-24H *	24" Lighted Warmer Toggle 208V	655	8	\$433.00
OHL24H3T	FDL-24H *	24" Lighted Warmer Toggle 240V	655	8	\$433.00
OHL24H1I	FDL-24H *	24" Lighted Warmer Infinite 120V	655	8	\$548.00
OHL24H2I	FDL-24H *	24" Lighted Warmer Infinite 208V	655	8	\$548.00
OHL24H3I	FDL-24H *	24" Lighted Warmer Infinite 240V	655	8	\$548.00
OHL30H1T	FDL-30H *	30" Lighted Warmer Toggle 120V	840	9	\$488.00
OHL30H2T	FDL-30H *	30" Lighted Warmer Toggle 208V	840	9	\$488.00
OHL30H3T	FDL-30H *	30" Lighted Warmer Toggle 240V	840	9	\$488.00
OHL30H1I	FDL-30H *	30" Lighted Warmer Infinite 120V	840	9	\$619.00
OHL30H2I	FDL-30H *	30" Lighted Warmer Infinite 208V	840	9	\$619.00
OHL30H3I	FDL-30H *	30" Lighted Warmer Infinite 240V	840	9	\$619.00
OHL36H1T	FDL-36H *	36" Lighted Warmer Toggle 120V	1080	11	\$537.00
OHL36H2T	FDL-36H *	36" Lighted Warmer Toggle 208V	1080	11	\$537.00
OHL36H3T	FDL-36H *	36" Lighted Warmer Toggle 240V	1080	11	\$537.00
OHL36H1I	FDL-36H *	36" Lighted Warmer Infinite 120V	1080	11	\$679.00
OHL36H2I	FDL-36H *	36" Lighted Warmer Infinite 208V	1080	11	\$679.00
OHL36H3I	FDL-36H *	36" Lighted Warmer Infinite 240V	1080	11	\$679.00
OHL42H1T	FDL-42H	42" Lighted Warmer Toggle 120V	1260	12	\$577.00
OHL42H2T	FDL-42H	42" Lighted Warmer Toggle 208V	1260	12	\$577.00
OHL42H3T	FDL-42H	42" Lighted Warmer Toggle 240V	1260	12	\$577.00
OHL42H1I	FDL-42H	42" Lighted Warmer Infinite 120V	1260	12	\$751.00
OHL42H2I	FDL-42H	42" Lighted Warmer Infinite 208V	1260	12	\$751.00
OHL42H3I	FDL-42H	42" Lighted Warmer Infinite 240V	1260	12	\$751.00
OHL48H1T	FDL-48H *	48" Lighted Warmer Toggle 120V	1425	12	\$637.00
OHL48H2T	FDL-48H *	48" Lighted Warmer Toggle 208V	1425	12	\$637.00
OHL48H3T	FDL-48H *	48" Lighted Warmer Toggle 240V	1425	12	\$637.00
OHL48H1I	FDL-48H *	48" Lighted Warmer Infinite 120V	1425	12	\$818.00
OHL48H2I	FDL-48H *	48" Lighted Warmer Infinite 208V	1425	12	\$818.00
OHL48H3I	FDL-48H *	48" Lighted Warmer Infinite 240V	1425	12	\$818.00
OHL54H1T	FDL-54H	54" Lighted Warmer Toggle 120V	1585	14	\$678.00
OHL54H2T	FDL-54H	54" Lighted Warmer Toggle 208V	1585	14	\$678.00
OHL54H3T	FDL-54H	54" Lighted Warmer Toggle 240V	1585	14	\$678.00
OHL54H2I	FDL-54H	54" Lighted Warmer Infinite 208V	1585	14	\$844.00
OHL54H3I	FDL-54H	54" Lighted Warmer Infinite 240V	1585	14	\$844.00
OHL60H1T	FDL-60H *	60" Lighted Warmer Toggle 120V	1850	15	\$755.00
OHL60H2T	FDL-60H *	60" Lighted Warmer Toggle 208V	1850	15	\$755.00
OHL60H3T	FDL-60 *	60" Lighted Warmer Toggle 240V	1850	15	\$755.00
OHL60H2I	FDL-60H *	60" Lighted Warmer Infinite 208V	1850	15	\$913.00
OHL60H3I	FDL-60H *	60" Lighted Warmer Infinite 240V	1850	15	\$913.00
OHL66H2T	FDL-66H	66" Lighted Warmer Toggle 208V	2040	17	\$816.00
OHL66H3T	FDL-66H	66" Lighted Warmer Toggle 240V	2040	17	\$816.00
OHL66H2I	FDL-66H	66" Lighted Warmer Infinite 208V	2040	17	\$980.00
OHL66H3I	FDL-66H	66" Lighted Warmer Infinite 240V	2040	17	\$980.00
OHL72H2T	FDL-72H *	72" Lighted Warmer Toggle 208V	2220	18	\$900.00
OHL72H3T	FDL-72H *	72" Lighted Warmer Toggle 240V	2220	18	\$900.00
OHL72H2I	FDL-72H *	72" Lighted Warmer Infinite 208V	2220	18	\$1,072.00
OHL72H3I	FDL-72H *	72" Lighted Warmer Infinite 240V	2220	18	\$1,072.00

* These models CSA approved
Remote units use toggle price.

Continued on next page

Overhead Warmer

SERIES

Lighted Single Standard Calrod Overhead Warmers *Continued*



Part Number	Model	Description	Watts	Weight (lbs)	Price
Energy Efficient					
OHL18L1T	FDL-18L *	18" Lighted Warmer Toggle 120V	330	7	\$402.00
OHL18L2T	FDL-18L *	18" Lighted Warmer Toggle 208V	330	7	\$402.00
OHL18L3T	FDL-18L *	18" Lighted Warmer Toggle 240V	330	7	\$402.00
OHL18L1I	FDL-18L *	18" Lighted Warmer Infinite 120V	330	7	\$450.00
OHL18L2I	FDL-18L *	18" Lighted Warmer Infinite 208V	330	7	\$450.00
OHL18L3I	FDL-18L *	18" Lighted Warmer Infinite 240V	330	7	\$450.00
OHL24L1T	FDL-24L *	24" Lighted Warmer Toggle 120V	430	8	\$420.00
OHL24L2T	FDL-24L *	24" Lighted Warmer Toggle 208V	430	8	\$420.00
OHL24L3T	FDL-24L *	24" Lighted Warmer Toggle 240V	430	8	\$420.00
OHL24L1I	FDL-24L *	24" Lighted Warmer Infinite 120V	430	8	\$548.00
OHL24L2I	FDL-24L *	24" Lighted Warmer Infinite 208V	430	8	\$548.00
OHL24L3I	FDL-24L *	24" Lighted Warmer Infinite 240V	430	8	\$548.00
OHL30L1T	FDL-30L *	30" Lighted Warmer Toggle 120V	530	9	\$477.00
OHL30L3T	FDL-30L *	30" Lighted Warmer Toggle 240V	530	9	\$477.00
OHL30L1I	FDL-30L *	30" Lighted Warmer Infinite 120V	530	9	\$606.00
OHL30L3I	FDL-30L *	30" Lighted Warmer Infinite 240V	530	9	\$606.00
OHL36L1T	FDL-36L *	36" Lighted Warmer Toggle 120V	735	11	\$528.00
OHL36L2T	FDL-36L *	36" Lighted Warmer Toggle 208V	735	11	\$528.00
OHL36L3T	FDL-36L *	36" Lighted Warmer Toggle 240V	735	11	\$528.00
OHL36L1I	FDL-36L *	36" Lighted Warmer Infinite 120V	735	11	\$673.00
OHL36L2I	FDL-36L *	36" Lighted Warmer Infinite 208V	735	11	\$673.00
OHL36L3I	FDL-36L *	36" Lighted Warmer Infinite 240V	735	11	\$673.00
OHL42L1T	FDL-42L	42" Lighted Warmer Toggle 120V	835	12	\$567.00
OHL42L2T	FDL-42L	42" Lighted Warmer Toggle 208V	835	12	\$567.00
OHL42L3T	FDL-42L	42" Lighted Warmer Toggle 240V	835	12	\$567.00
OHL42L1I	FDL-42L	42" Lighted Warmer Infinite 120V	835	12	\$720.00
OHL42L2I	FDL-42L	42" Lighted Warmer Infinite 208V	835	12	\$720.00
OHL42L3I	FDL-42L	42" Lighted Warmer Infinite 240V	835	12	\$720.00
OHL48L1T	FDL-48L *	48" Lighted Warmer Toggle 120V	960	12	\$629.00
OHL48L2T	FDL-48L *	48" Lighted Warmer Toggle 208V	960	12	\$629.00
OHL48L3T	FDL-48L *	48" Lighted Warmer Toggle 240V	960	12	\$629.00
OHL48L1I	FDL-48L *	48" Lighted Warmer Infinite 120V	960	12	\$785.00
OHL48L2I	FDL-48L *	48" Lighted Warmer Infinite 208V	960	12	\$785.00
OHL48L3I	FDL-48L *	48" Lighted Warmer Infinite 240V	960	12	\$785.00
OHL54L1T	FDL-54L	54" Lighted Warmer Toggle 120V	1085	14	\$666.00
OHL54L2T	FDL-54L	54" Lighted Warmer Toggle 208V	1085	14	\$666.00
OHL54L3T	FDL-54L	54" Lighted Warmer Toggle 240V	1085	14	\$666.00
OHL54L1I	FDL-54L	54" Lighted Warmer Infinite 120V	1085	14	\$851.00
OHL54L2I	FDL-54L	54" Lighted Warmer Infinite 208V	1085	14	\$851.00
OHL54L3I	FDL-54L	54" Lighted Warmer Infinite 240V	1085	14	\$851.00
OHL60L1T	FDL-60L *	60" Lighted Warmer Toggle 120V	1290	15	\$752.00
OHL60L2T	FDL-60L *	60" Lighted Warmer Toggle 208V	1290	15	\$752.00
OHL60L3T	FDL-60L *	60" Lighted Warmer Toggle 240V	1290	15	\$752.00
OHL60L1I	FDL-60L *	60" Lighted Warmer Infinite 120V	1290	15	\$934.00
OHL60L2I	FDL-60L *	60" Lighted Warmer Infinite 208V	1290	15	\$934.00
OHL60L3I	FDL-60L *	60" Lighted Warmer Infinite 240V	1290	15	\$934.00
OHL66L3T	FDL-66L	66" Lighted Warmer Toggle 240V	1400	17	\$821.00
OHL66L3I	FDL-66L	66" Lighted Warmer Infinite 240V	1400	17	\$996.00
OHL72L2T	FDL-72L *	72" Lighted Warmer Toggle 208V	1515	18	\$897.00
OHL72L3T	FDL-72L *	72" Lighted Warmer Toggle 240V	1515	18	\$897.00
OHL72L2I	FDL-72L *	72" Lighted Warmer Infinite 208V	1515	18	\$1,178.00
OHL72L3I	FDL-72L *	72" Lighted Warmer Infinite 240V	1515	18	\$1,178.00

* These models CSA approved
Remote units use toggle price.

Overhead Warmer

SERIES

Double Standard Calrod Overhead Warmers

Double Units are 15 1/8" wide and 2 1/2" high. See mountings instruction on page 37. Add -T for toggle or -I for Infinite controls. Remote control boxes are recommended (Add R). 18" to 48" available in 120V, 208V, or 240V. 54-60" available in 208V or 240V. If shipping via air freight, dimensional weights apply. Backed by APW's Two Year Parts and One Year Labor Warranty. FOB Standex Dock, freight class 100. 60" and above must ship LTL.

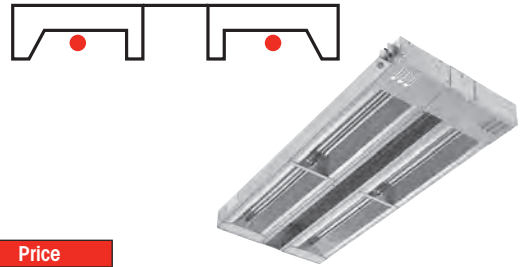

Part Number	Model	Description	Watts	Weight (lbs)	Price
High Performance, Fast Recovery					
OHD18H1T	FDD-18H	18" Warmer Toggle 120V	800	12	\$647.00
OHD18H2T	FDD-18H	18" Warmer Toggle 208V	800	12	\$647.00
OHD18H1I	FDD-18H	18" Warmer Infinite 120V	800	12	\$674.00
OHD18H2I	FDD-18H	18" Warmer Infinite 208V	800	12	\$674.00
OHD24H1T	FDD-24H	24" Warmer Toggle 120V	1150	16	\$689.00
OHD24H2T	FDD-24H	24" Warmer Toggle 208V	1150	16	\$689.00
OHD24H3T	FDD-24H	24" Warmer Toggle 240V	1150	16	\$689.00
OHD24H1I	FDD-24H	24" Warmer Infinite 120V	1150	16	\$744.00
OHD24H2I	FDD-24H	24" Warmer Infinite 208V	1150	16	\$744.00
OHD24H3I	FDD-24H	24" Warmer Infinite 240V	1150	16	\$744.00
OHD30H1T	FDD-30H	30" Warmer Toggle 120V	1520	18	\$744.00
OHD30H2T	FDD-30H	30" Warmer Toggle 208V	1520	18	\$744.00
OHD30H3T	FDD-30H	30" Warmer Toggle 240V	1520	18	\$744.00
OHD30H1I	FDD-30H	30" Warmer Infinite 120V	1520	18	\$804.00
OHD30H2I	FDD-30H	30" Warmer Infinite 208V	1520	18	\$804.00
OHD30H3I	FDD-30H	30" Warmer Infinite 240V	1520	18	\$804.00
OHD36H1T	FDD-36H	36" Warmer Toggle 120V	1840	21	\$819.00
OHD36H2T	FDD-36H	36" Warmer Toggle 208V	1840	21	\$819.00
OHD36H3T	FDD-36H	36" Warmer Toggle 240V	1840	21	\$819.00
OHD36H1I	FDD-36H	36" Warmer Infinite 120V	1840	21	\$873.00
OHD36H2I	FDD-36H	36" Warmer Infinite 208V	1840	21	\$873.00
OHD36H3I	FDD-36H	36" Warmer Infinite 240V	1840	21	\$873.00
OHD42H1T	FDD-42H	42" Warmer Toggle 120V	2200	24	\$836.00
OHD42H2T	FDD-42H	42" Warmer Toggle 208V	2200	24	\$836.00
OHD42H3T	FDD-42H	42" Warmer Toggle 240V	2200	24	\$836.00
OHD42H1I	FDD-42H	42" Warmer Infinite 120V	2200	24	\$969.00
OHD42H2I	FDD-42H	42" Warmer Infinite 208V	2200	24	\$969.00
OHD42H3I	FDD-42H	42" Warmer Infinite 240V	2200	24	\$969.00
OHD48H1T	FDD-48H	48" Warmer Toggle 120V	2530	25	\$955.00
OHD48H2T	FDD-48H	48" Warmer Toggle 208V	2530	25	\$955.00
OHD48H3T	FDD-48H	48" Warmer Toggle 240V	2530	25	\$955.00
OHD48H1I	FDD-48H	48" Warmer Infinite 120V	2530	25	\$988.00
OHD48H2I	FDD-48H	48" Warmer Infinite 208V	2530	25	\$988.00
OHD48H3I	FDD-48H	48" Warmer Infinite 240V	2530	25	\$988.00
OHD54H1T	FDD-54H	54" Warmer Toggle 120V	2850	28	\$1,023.00
OHD54H2T	FDD-54H	54" Warmer Toggle 208V	2850	28	\$1,023.00
OHD54H3T	FDD-54H	54" Warmer Toggle 240V	2850	28	\$1,023.00
OHD54H1I	FDD-54H	54" Warmer Infinite 120V	2850	28	\$1,063.00
OHD54H2I	FDD-54H	54" Warmer Infinite 208V	2850	28	\$1,063.00
OHD54H3I	FDD-54H	54" Warmer Infinite 240V	2850	28	\$1,063.00
OHD60H1T	FDD-60H	60" Warmer Toggle 120V	3220	30	\$1,123.00
OHD60H2T	FDD-60H	60" Warmer Toggle 208V	3220	30	\$1,123.00
OHD60H3T	FDD-60H	60" Warmer Toggle 240V	3220	30	\$1,123.00
OHD60H2I	FDD-60H	60" Warmer Infinite 208V	3220	30	\$1,159.00
OHD60H3I	FDD-60H	60" Warmer Infinite 240V	3220	30	\$1,159.00
OHD66H2T	FDD-66H	66" Warmer Toggle 208V	3600	34	\$1,215.00
OHD66H3T	FDD-66H	66" Warmer Toggle 240V	3600	34	\$1,215.00
OHD66H2I	FDD-66H	66" Warmer Infinite 208V	3600	34	\$1,313.00
OHD66H3I	FDD-66H	66" Warmer Infinite 240V	3600	34	\$1,313.00
OHD72H2T	FDD-72H	72" Warmer Toggle 208V	3960	36	\$1,348.00
OHD72H3T	FDD-72H	72" Warmer Toggle 240V	3960	36	\$1,348.00
OHD72H2I	FDD-72H	72" Warmer Infinite 208V	3960	36	\$1,378.00
OHD72H3I	FDD-72H	72" Warmer Infinite 240V	3960	36	\$1,378.00



Remote units use toggle price.

Continued on next page

Overhead Warmer

SERIES

Double Standard Calrod Overhead Warmers *Continued*



Part Number	Model	Description	Watts	Weight (lbs)	Price
Energy Efficient					
OHD18L1T	FDD-18L	18" Warmer Toggle 120V	500	12	\$633.00
OHD18L2T	FDD-18L	18" Warmer Toggle 208V	500	12	\$633.00
OHD18L3T	FDD-18L	18" Warmer Toggle 240V	500	12	\$633.00
OHD18L1I	FDD-18L	18" Warmer Infinite 120V	500	12	\$666.00
OHD18L2I	FDD-18L	18" Warmer Infinite 208V	500	12	\$666.00
OHD18L3I	FDD-18L	18" Warmer Infinite 240V	500	12	\$666.00
OHD24L1T	FDD-24L	24" Warmer Toggle 120V	700	16	\$678.00
OHD24L2T	FDD-24L	24" Warmer Toggle 208V	700	16	\$678.00
OHD24L3T	FDD-24L	24" Warmer Toggle 240V	700	16	\$678.00
OHD24L1I	FDD-24L	24" Warmer Infinite 120V	700	16	\$735.00
OHD24L2I	FDD-24L	24" Warmer Infinite 208V	700	16	\$735.00
OHD24L3I	FDD-24L	24" Warmer Infinite 240V	700	16	\$735.00
OHD30L1T	FDD-30L	30" Warmer Toggle 120V	900	18	\$734.00
OHD30L3T	FDD-30L	30" Warmer Toggle 240V	900	18	\$734.00
OHD30L1I	FDD-30L	30" Warmer Infinite 120V	900	18	\$799.00
OHD30L3I	FDD-30L	30" Warmer Infinite 240V	900	18	\$799.00
OHD36L1T	FDD-36L	36" Warmer Toggle 120V	1150	22	\$812.00
OHD36L2T	FDD-36L	36" Warmer Toggle 208V	1150	22	\$812.00
OHD36L3T	FDD-36L	36" Warmer Toggle 240V	1150	22	\$812.00
OHD36L1I	FDD-36L	36" Warmer Infinite 120V	1150	22	\$867.00
OHD36L2I	FDD-36L	36" Warmer Infinite 208V	1150	22	\$867.00
OHD36L3I	FDD-36L	36" Warmer Infinite 240V	1150	22	\$867.00
OHD42L1T	FDD-42L	42" Warmer Toggle 120V	1350	24	\$872.00
OHD42L2T	FDD-42L	42" Warmer Toggle 208V	1350	24	\$872.00
OHD42L3T	FDD-42L	42" Warmer Toggle 240V	1350	24	\$872.00
OHD42L1I	FDD-42L	42" Warmer Infinite 120V	1350	24	\$935.00
OHD42L2I	FDD-42L	42" Warmer Infinite 208V	1350	24	\$935.00
OHD42L3I	FDD-42L	42" Warmer Infinite 240V	1350	24	\$935.00
OHD48L1T	FDD-48L	48" Warmer Toggle 120V	1600	24	\$941.00
OHD48L2T	FDD-48L	48" Warmer Toggle 208V	1600	24	\$941.00
OHD48L3T	FDD-48L	48" Warmer Toggle 240V	1600	24	\$941.00
OHD48L1I	FDD-48L	48" Warmer Infinite 120V	1600	24	\$984.00
OHD48L2I	FDD-48L	48" Warmer Infinite 208V	1600	24	\$984.00
OHD48L3I	FDD-48L	48" Warmer Infinite 240V	1600	24	\$984.00
OHD54L1T	FDD-54L	54" Warmer Toggle 120V	1850	28	\$1,004.00
OHD54L2T	FDD-54L	54" Warmer Toggle 208V	1850	28	\$1,004.00
OHD54L3T	FDD-54L	54" Warmer Toggle 240V	1850	28	\$1,004.00
OHD54L1I	FDD-54L	54" Warmer Infinite 120V	1850	28	\$1,054.00
OHD54L2I	FDD-54L	54" Warmer Infinite 208V	1850	28	\$1,054.00
OHD54L3I	FDD-54L	54" Warmer Infinite 240V	1850	28	\$1,054.00
OHD60L1T	FDD-60L	60" Warmer Toggle 120V	2100	30	\$1,108.00
OHD60L2T	FDD-60L	60" Warmer Toggle 208V	2100	30	\$1,108.00
OHD60L3T	FDD-60L	60" Warmer Toggle 240V	2100	30	\$1,108.00
OHD60L1I	FDD-60L	60" Warmer Infinite 120V	2100	30	\$1,151.00
OHD60L2I	FDD-60L	60" Warmer Infinite 208V	2100	30	\$1,151.00
OHD60L3I	FDD-60L	60" Warmer Infinite 240V	2100	30	\$1,151.00
OHD66L3T	FDD-66L	66" Warmer Toggle 240V	2320	34	\$1,236.00
OHD66L3I	FDD-66L	66" Warmer Infinite 240V	2320	34	\$1,309.00
OHD72L2T	FDD-72L	72" Warmer Toggle 208V	2550	36	\$1,342.00
OHD72L3T	FDD-72L	72" Warmer Toggle 240V	2550	36	\$1,342.00
OHD72L2I	FDD-72L	72" Warmer Infinite 208V	2550	36	\$1,348.00
OHD72L3I	FDD-72L	72" Warmer Infinite 240V	2550	36	\$1,348.00

Remote units use toggle price.

Overhead Warmer

SERIES

Lighted Double Standard Calrod Overhead Warmers

Double Units are 15 1/8" wide and 2 1/2" high. See Mounting instructions on page 38. Remote control boxes are recommended (Add R). Note: Unit and Light are the same voltage. If shipping via air freight, dimensional weights apply. Backed by APW's Two Year Parts and One Year Labor Warranty. FOB Standex Dock, freight class 100. 60" and above must ship LTL.



Part Number	Model	Description	Watts	Weight (lbs)	Price
High Performance, Fast Recovery					
OHDL18H1T	FDDL-18H	18" Lighted Warmer Toggle 120V	880	13	\$689.00
OHDL18H2T	FDDL-18H	18" Lighted Warmer Toggle 208V	880	13	\$689.00
OHDL18H1I	FDDL-18H	18" Lighted Warmer Infinite 120V	880	13	\$739.00
OHDL18H2I	FDDL-18H	18" Lighted Warmer Infinite 208V	880	13	\$739.00
OHDL24H1T	FDDL-24H	24" Lighted Warmer Toggle 120V	1230	17	\$745.00
OHDL24H2T	FDDL-24H	24" Lighted Warmer Toggle 208V	1230	17	\$745.00
OHDL24H3T	FDDL-24H	24" Lighted Warmer Toggle 240V	1230	17	\$745.00
OHDL24H1I	FDDL-24H	24" Lighted Warmer Infinite 120V	1230	17	\$868.00
OHDL24H2I	FDDL-24H	24" Lighted Warmer Infinite 208V	1230	17	\$868.00
OHDL24H3I	FDDL-24H	24" Lighted Warmer Infinite 240V	1230	17	\$868.00
OHDL30H1T	FDDL-30H	30" Lighted Warmer Toggle 120V	1600	19	\$827.00
OHDL30H2T	FDDL-30H	30" Lighted Warmer Toggle 208V	1600	19	\$827.00
OHDL30H3T	FDDL-30H	30" Lighted Warmer Toggle 240V	1600	19	\$827.00
OHDL30H1I	FDDL-30H	30" Lighted Warmer Infinite 120V	1600	19	\$953.00
OHDL30H2I	FDDL-30H	30" Lighted Warmer Infinite 208V	1600	19	\$953.00
OHDL30H3I	FDDL-30H	30" Lighted Warmer Infinite 240V	1600	19	\$953.00
OHDL36H1T	FDDL-36H	36" Lighted Warmer Toggle 120V	2000	22	\$906.00
OHDL36H2T	FDDL-36H	36" Lighted Warmer Toggle 208V	2000	22	\$906.00
OHDL36H3T	FDDL-36H	36" Lighted Warmer Toggle 240V	2000	22	\$906.00
OHDL36H1I	FDDL-36H	36" Lighted Warmer Infinite 120V	2000	22	\$1,026.00
OHDL36H2I	FDDL-36H	36" Lighted Warmer Infinite 208V	2000	22	\$1,026.00
OHDL36H3I	FDDL-36H	36" Lighted Warmer Infinite 240V	2000	22	\$1,026.00
OHDL42H1T	FDDL-42H	42" Lighted Warmer Toggle 120V	2360	25	\$995.00
OHDL42H2T	FDDL-42H	42" Lighted Warmer Toggle 208V	2360	25	\$995.00
OHDL42H3T	FDDL-42H	42" Lighted Warmer Toggle 240V	2360	25	\$995.00
OHDL42H1I	FDDL-42H	42" Lighted Warmer Infinite 120V	2360	25	\$1,091.00
OHDL42H2I	FDDL-42H	42" Lighted Warmer Infinite 208V	2360	25	\$1,091.00
OHDL42H3I	FDDL-42H	42" Lighted Warmer Infinite 240V	2360	25	\$1,091.00
OHDL48H1T	FDDL-48H	48" Lighted Warmer Toggle 120V	2690	26	\$1,124.00
OHDL48H2T	FDDL-48H	48" Lighted Warmer Toggle 208V	2690	26	\$1,124.00
OHDL48H3T	FDDL-48H	48" Lighted Warmer Toggle 240V	2690	26	\$1,124.00
OHDL48H1I	FDDL-48H	48" Lighted Warmer Infinite 120V	2690	26	\$1,156.00
OHDL48H2I	FDDL-48H	48" Lighted Warmer Infinite 208V	2690	26	\$1,156.00
OHDL48H3I	FDDL-48H	48" Lighted Warmer Infinite 240V	2690	26	\$1,156.00
OHDL54H1T	FDDL-54H	54" Lighted Warmer Toggle 120V	3010	29	\$1,149.00
OHDL54H2T	FDDL-54H	54" Lighted Warmer Toggle 208V	3010	29	\$1,149.00
OHDL54H3T	FDDL-54H	54" Lighted Warmer Toggle 240V	3010	29	\$1,149.00
OHDL54H1I	FDDL-54H	54" Lighted Warmer Infinite 120V	3010	29	\$1,221.00
OHDL54H2I	FDDL-54H	54" Lighted Warmer Infinite 208V	3010	29	\$1,221.00
OHDL54H3I	FDDL-54H	54" Lighted Warmer Infinite 240V	3010	29	\$1,221.00
OHDL60H1T	FDDL-60H	60" Lighted Warmer Toggle 120V	3460	31	\$1,263.00
OHDL60H2T	FDDL-60H	60" Lighted Warmer Toggle 208V	3460	31	\$1,263.00
OHDL60H3T	FDDL-60H	60" Lighted Warmer Toggle 240V	3460	31	\$1,263.00
OHDL60H2I	FDDL-60H	60" Lighted Warmer Infinite 208V	3460	31	\$1,360.00
OHDL60H3I	FDDL-60H	60" Lighted Warmer Infinite 240V	3460	31	\$1,360.00
OHDL66H2T	FDDL-66H	66" Lighted Warmer Toggle 208V	3840	35	\$1,380.00
OHDL66H3T	FDDL-66H	66" Lighted Warmer Toggle 240V	3840	35	\$1,380.00
OHDL66H2I	FDDL-66H	66" Lighted Warmer Infinite 208V	3840	35	\$1,481.00
OHDL66H3I	FDDL-66H	66" Lighted Warmer Infinite 240V	3840	35	\$1,481.00
OHDL72H2T	FDDL-72H	72" Lighted Warmer Toggle 208V	4200	37	\$1,535.00
OHDL72H3T	FDDL-72H	72" Lighted Warmer Toggle 240V	4200	37	\$1,535.00
OHDL72H2I	FDDL-72H	72" Lighted Warmer Infinite 208V	4200	37	\$1,612.00
OHDL72H3I	FDDL-72H	72" Lighted Warmer Infinite 240V	4200	37	\$1,612.00

Remote units use toggle price.

Continued on next page

Overhead Warmer

SERIES

Lighted Double Standard Calrod Overhead Warmers *Continued*

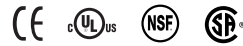

Part Number	Model	Description	Watts	Weight (lbs)	Price
Energy Efficient					
OHDL18L1T	FDDL-18L	18" Lighted Warmer Toggle 120V	580	13	\$678.00
OHDL18L2T	FDDL-18L	18" Lighted Warmer Toggle 208V	580	13	\$678.00
OHDL18L3T	FDDL-18L	18" Lighted Warmer Toggle 240V	580	13	\$678.00
OHDL18L1I	FDDL-18L	18" Lighted Warmer Infinite 120V	580	13	\$770.00
OHDL18L2I	FDDL-18L	18" Lighted Warmer Infinite 208V	580	13	\$770.00
OHDL18L3I	FDDL-18L	18" Lighted Warmer Infinite 240V	580	13	\$770.00
OHDL24L1T	FDDL-24L	24" Lighted Warmer Toggle 120V	780	17	\$726.00
OHDL24L2T	FDDL-24L	24" Lighted Warmer Toggle 208V	780	17	\$726.00
OHDL24L3T	FDDL-24L	24" Lighted Warmer Toggle 240V	780	17	\$726.00
OHDL24L1I	FDDL-24L	24" Lighted Warmer Infinite 120V	780	17	\$860.00
OHDL24L2I	FDDL-24L	24" Lighted Warmer Infinite 208V	780	17	\$860.00
OHDL24L3I	FDDL-24L	24" Lighted Warmer Infinite 240V	780	17	\$860.00
OHDL30L1T	FDDL-30L	30" Lighted Warmer Toggle 120V	980	19	\$809.00
OHDL30L3T	FDDL-30L	30" Lighted Warmer Toggle 240V	980	19	\$809.00
OHDL30L1I	FDDL-30L	30" Lighted Warmer Infinite 120V	980	19	\$948.00
OHDL30L3I	FDDL-30L	30" Lighted Warmer Infinite 240V	980	19	\$948.00
OHDL36L1T	FDDL-36L	36" Lighted Warmer Toggle 120V	1310	22	\$894.00
OHDL36L2T	FDDL-36L	36" Lighted Warmer Toggle 208V	1310	22	\$894.00
OHDL36L3T	FDDL-36L	36" Lighted Warmer Toggle 240V	1310	22	\$894.00
OHDL36L1I	FDDL-36L	36" Lighted Warmer Infinite 120V	1310	22	\$1,031.00
OHDL36L2I	FDDL-36L	36" Lighted Warmer Infinite 208V	1310	22	\$1,031.00
OHDL36L3I	FDDL-36L	36" Lighted Warmer Infinite 240V	1310	22	\$1,031.00
OHDL42L1T	FDDL-42L	42" Lighted Warmer Toggle 120V	1510	25	\$970.00
OHDL42L2T	FDDL-42L	42" Lighted Warmer Toggle 208V	1510	25	\$970.00
OHDL42L3T	FDDL-42L	42" Lighted Warmer Toggle 240V	1510	25	\$970.00
OHDL42L1I	FDDL-42L	42" Lighted Warmer Infinite 120V	1510	25	\$1,096.00
OHDL42L2I	FDDL-42L	42" Lighted Warmer Infinite 208V	1510	25	\$1,096.00
OHDL42L3I	FDDL-42L	42" Lighted Warmer Infinite 240V	1510	25	\$1,096.00
OHDL48L1T	FDDL-48L	48" Lighted Warmer Toggle 120V	1760	26	\$1,053.00
OHDL48L2T	FDDL-48L	48" Lighted Warmer Toggle 208V	1760	26	\$1,053.00
OHDL48L3T	FDDL-48L	48" Lighted Warmer Toggle 240V	1760	26	\$1,053.00
OHDL48L1I	FDDL-48L	48" Lighted Warmer Infinite 120V	1760	26	\$1,158.00
OHDL48L2I	FDDL-48L	48" Lighted Warmer Infinite 208V	1760	26	\$1,158.00
OHDL48L3I	FDDL-48L	48" Lighted Warmer Infinite 240V	1760	26	\$1,158.00
OHDL54L1T	FDDL-54L	54" Lighted Warmer Toggle 120V	2010	29	\$1,130.00
OHDL54L2T	FDDL-54L	54" Lighted Warmer Toggle 208V	2010	29	\$1,130.00
OHDL54L3T	FDDL-54L	54" Lighted Warmer Toggle 240V	2010	29	\$1,130.00
OHDL54L1I	FDDL-54L	54" Lighted Warmer Infinite 120V	2010	29	\$1,222.00
OHDL54L2I	FDDL-54L	54" Lighted Warmer Infinite 208V	2010	29	\$1,222.00
OHDL54L3I	FDDL-54L	54" Lighted Warmer Infinite 240V	2010	29	\$1,222.00
OHDL60L1T	FDDL-60L	60" Lighted Warmer Toggle 120V	2340	31	\$1,255.00
OHDL60L2T	FDDL-60L	60" Lighted Warmer Toggle 208V	2340	31	\$1,255.00
OHDL60L3T	FDDL-60L	60" Lighted Warmer Toggle 240V	2340	31	\$1,255.00
OHDL60L1I	FDDL-60L	60" Lighted Warmer Infinite 120V	2340	31	\$1,321.00
OHDL60L2I	FDDL-60L	60" Lighted Warmer Infinite 208V	2340	31	\$1,321.00
OHDL60L3I	FDDL-60L	60" Lighted Warmer Infinite 240V	2340	31	\$1,321.00
OHDL66L3T	FDDL-66L	66" Lighted Warmer Toggle 240V	2560	35	\$1,367.00
OHDL66L3I	FDDL-66L	66" Lighted Warmer Infinite 240V	2560	35	\$1,419.00
OHDL72L2T	FDDL-72L	72" Lighted Warmer Toggle 208V	2790	37	\$1,515.00
OHDL72L3T	FDDL-72L	72" Lighted Warmer Toggle 240V	2790	37	\$1,515.00
OHDL72L2I	FDDL-72L	72" Lighted Warmer Infinite 208V	2790	37	\$1,572.00
OHDL72L3I	FDDL-72L	72" Lighted Warmer Infinite 240V	2790	37	\$1,572.00

Remote units use toggle price.

Overhead Warmer SERIES

Overhead Warmer Options



Part Number	Options	Price
76481	Remote Control Box Enclosure for toggle 120/208/240V	\$143.00
76482	Remote Control Box Enclosure for (1) infinite 120V	\$159.00
76977	Remote Control Box Enclosure for (1) infinite 208V	\$163.00
76483	Remote Control Box Enclosure for (1) infinite 240V	\$163.00
76484	Remote Control Box Enclosure for (2) toggles 120/208/240V	\$156.00
76485	Remote Control Box Enclosure for (2) infinite 120V	\$225.00
76978	Remote Control Box Enclosure for (2) infinite 208V	\$218.00
76486	Remote Control Box Enclosure for (2) infinite 240V	\$225.00
70402012	Remote Control Box Enclosure for (1) infinite 208V, (1) toggle 120V-240V, (1) indicator light	\$202.00
70402013	Remote Control Box Enclosure for (1) infinite 240V, (1) toggle 120V	\$208.00
70402016	Remote Control Box Enclosure for (1) infinite 120V, (1) toggle 120V	\$202.00
76487	Remote Control Box Enclosure for (3) toggles 120/208/240V	\$219.00
76488	Remote Control Box Enclosure for (3) infinite 120V	\$265.00
76979	Remote Control Box Enclosure for (3) infinite 208V	\$265.00
76489	Remote Control Box Enclosure for (3) infinite 240V	\$265.00
75906	Cord and plug set for portability, 120V, 1440W, factory installed for single units up to 48" (6' Cord)	\$53.00
76099	Cord and plug set for portability, 208/240V, factory installed for single units up to 72" (3' Cord & plug)	\$59.00
Mounting Options:		
76180*	Tubular stand kit with one pair legs for permanent countertop mounting single units only. Up to 48"	\$164.00
76200*	Portable leg kit with one pair legs and accessories so overhead stands freely single units only. Up to 48"	\$186.00
75901	Chain supports (per foot) to suspend overheads when flush mount won't do	\$20.00



REMOTE CONTROL BOX
Single Remote control box measures 2 1/2"H x 4"L x 2 1/2"D. Need one control per strip. Dual units need 2 controls.

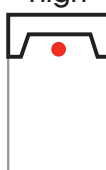
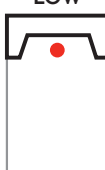
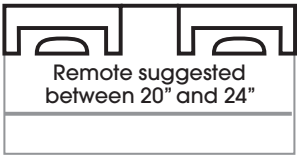
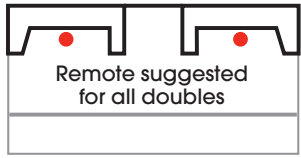

Overhead Mounting Heights

C*Radiant™		Calrod	
Single Units - Non-Flammable Surface			
High  18"	Low  14"	High  16"	Low  16"
Double Units - Non-Flammable Surface			
 Remote suggested between 20" and 24" 24" (high) 18" (low)		 Remote suggested for all doubles 24"	
Single & Double Units - Flammable Surface			
Not Available		Low Watt 30"	High Watt 40"

Please consult factory rep or technical service with your application questions.

* 14"-18" Low and High watt on infinite controls only, 10"-14" Low and High watt on Remote only.

X*PERT™ Holding Drawer SERIES

X*PERT™ Holding Drawers

Our unique countertop and built-in holding drawers combine precise intuitive controls with durable construction to provide safe food holding solutions that are simple to use, easy to clean and last a lifetime.

X*PERT™ Series Ease*Extreme Digital Holding Drawers

The Ease*Extreme Holding Drawers feature "easy access" control panels. Ease*Extreme Drawers are designed with a tough Stainless Steel Construction and Heavy-Duty Drawer Slide, making it one of the most durable in the industry. Drawer slides now feature the "Easy Roller" design that eliminates the problem of drawers jamming as you close them. The Ease*Extreme Holding Drawers have perimeter heating elements, thermostatic controls, and moisture control vents. Ease*Extreme are supplied with an easy to read digital control system that keeps the tightest control over interior temperatures. Cord and plug and 6" pan included. All models of HDXi's cannot ship UPS. If shipping via air freight, dimensional weights apply. Backed by APW's One Year Warranty. FOB Standex Dock, freight class 100.



Part Number	Model	Description	Electric	Dimensions	Weight (lbs)	Price
70503050	HDXi-1	Single Drawer	120V, 450W, 3.8 Amps	20"H x 25 1/2"W x 21"D	120	\$2,349.00
Contact CS	HDXi-1	Single Drawer	208V, 450W, 2.1A, 240V, 450W, 1.8 Amps	20"H x 25 1/2"W x 21"D	120	\$2,349.00
70503060	HDXi-2	Double Drawer	120V, 900W, 7.5 Amps	28"H x 25 1/2"W x 21"D	170	\$4,027.00
Contact CS	HDXi-2	Double Drawer	208V, 900W, 4.3A, 240V, 900, 3.7 Amps	28"H x 25 1/2"W x 21"D	170	\$4,027.00
70503070	HDXi-3	Triple Drawer	120V, 1350W, 11.3 Amps	38"H x 25 1/2"W x 21"D	220	\$5,693.00
Contact CS	HDXi-3	Triple Drawer	208V, 450W, 6.5, 240V, 450W, 5.6 Amps	38"H x 25 1/2"W x 21"D	220	\$5,693.00
70503080	HDXi-4	Four Drawer	120V, 1800W, 15 Amps	48"H x 25 1/2"W x 21"D	270	\$7,452.00
70503081	HDXi-4	Four Drawer	208V, 1800W, 8.6A, 240V, 1800W, 7.5 Amps	48"H x 25 1/2"W x 21"D	270	\$7,452.00

X*PERT™ Series Countertop Standard Holding Drawers

Holding Drawers feature perimeter heating elements, thermostatic controls, rolling readout thermometers, and moisture control vents. Stainless Steel construction and Heavy-Duty Drawer Slide is one of the most durable in the industry. Drawer slides now feature the "Easy Roller" design that eliminates the problem of drawers jamming as you close them. Cord and plug and 6" pan included. All models of HDDi's cannot ship UPS. If shipping via air freight, dimensional weights apply. Backed by APW's One Year Warranty. FOB Standex Dock, freight class 100.



Part Number	Model	Description	Electric	Dimensions	Weight (lbs)	Price
70503010	HDDi-1	Single Drawer	120V, 450W, 3.8 Amps	14 15/16"H x 27 3/4"W x 21"D	120	\$2,219.00
70503011	HDDi-1	Single Drawer	208V, 450W, 2.1 Amps	14 15/16"H x 27 3/4"W x 21"D	120	\$2,219.00
70503012	HDDi-1	Single Drawer	240V, 450W, 1.8 Amps	14 15/16"H x 27 3/4"W x 21"D	120	\$2,219.00
70503020	HDDi-2	Double Drawer	120V, 900W, 7.5 Amps	24 5/16"H x 27 3/4"W x 21"D	170	\$3,789.00
70503021	HDDi-2	Double Drawer	208V, 900W, 4.3 Amps	24 5/16"H x 27 3/4"W x 21"D	170	\$3,789.00
70503022	HDDi-2	Double Drawer	240V, 900W, 3.7 Amps	24 5/16"H x 27 3/4"W x 21"D	170	\$3,789.00
70503030	HDDi-3	Triple Drawer	120V, 1350W, 11.3 Amps	33 11/16"H x 27 3/4"W x 21"D	220	\$5,326.00
70503031	HDDi-3	Triple Drawer	208V, 1350W, 6.5 Amps	33 11/16"H x 27 3/4"W x 21"D	220	\$5,326.00
70503032	HDDi-3	Triple Drawer	240V, 1350W, 5.6 Amps	33 11/16"H x 27 3/4"W x 21"D	220	\$5,326.00

X*PERT™ Series Slimline Countertop Standard Holding Drawers

Slimline Holding Drawers are designed to take up 30% less frontage space. Warming system features new perimeter heating elements, thermostatic controls, rolling readout thermometers, and moisture control vents. Stainless Steel construction and Heavy-Duty Drawer Slide is one of the most durable in the industry. Drawer slides now feature the "Easy Roller" design that eliminates the problem of drawers jamming as you close them. Cord and plug and 6" pan included. All models of HDDiS's cannot ship UPS. If shipping via air freight, dimensional weights apply. Backed by APW's One Year Warranty. FOB Standex Dock, freight class 100.

Part Number	Model	Description	Electric	Dimensions	Weight (lbs)	Price
70503210	HDDiS-1	Single Drawer	120V, 450W, 3.8 Amps	15 7/16"H x 20 1/4"W x 29 15/16"D	120	\$2,265.00
70503211	HDDiS-1	Single Drawer	208V, 450W, 2.1 Amps	15 7/16"H x 20 1/4"W x 29 15/16"D	120	\$2,265.00
70503212	HDDiS-1	Single Drawer	240V, 450W, 1.8 Amps	15 7/16"H x 20 1/4"W x 29 15/16"D	120	\$2,265.00
70503220	HDDiS-2	Double Drawer	120V, 900W, 7.5 Amps	25 15/16"H x 20 1/4"W x 29 15/16"D	170	\$3,829.00
70503221	HDDiS-2	Double Drawer	208V, 900W, 4.3 Amps	25 15/16"H x 20 1/4"W x 29 15/16"D	170	\$3,829.00
70503222	HDDiS-2	Double Drawer	240V, 900W, 3.7 Amps	25 15/16"H x 20 1/4"W x 29 15/16"D	170	\$3,829.00
70503230	HDDiS-3	Triple Drawer	120V, 1350W, 11.3 Amps	35 1/8"H x 20 1/4"W x 29 15/16"D	220	\$5,271.00
70503231	HDDiS-3	Triple Drawer	208V, 1350W, 6.5 Amps	35 1/8"H x 20 1/4"W x 29 15/16"D	220	\$5,271.00
70503232	HDDiS-3	Triple Drawer	240V, 1350W, 5.6 Amps	35 1/8"H x 20 1/4"W x 29 15/16"D	220	\$5,271.00

X*PERT™ Holding Drawer SERIES

X*PERT™ Series Built-In Holding Drawers

Holding Drawers that can be built directly into counters. Designed with a terminal block for easy wiring. Features Warming system, Heavy-Duty Stainless Steel construction, 6" pan, and moisture control vents. Drawer slides now feature the "Easy Roller" design that eliminates the problem of drawers jamming as you close them. Dimensions are base unit size, does not include the flange extensions. All models of HDDi-B's cannot ship UPS. If shipping via air freight, dimensional weights apply. Backed by APW's One Year Warranty. FOB Standex Dock, freight class 100.



Part Number	Model	Description	Electric	Dimensions	Weight (lbs)	Price
70503110	HDDi-1B	Single Drawer	120V, 450W, 3.8 Amps	10 3/8"H x 27 7/8"W x 20 11/16"D	120	\$2,247.00
70503111	HDDi-1B	Single Drawer	208V, 450W, 2.1 Amps	10 3/8"H x 27 7/8"W x 20 11/16"D	120	\$2,247.00
70503112	HDDi-1B	Single Drawer	240V, 450W, 1.8 Amps	10 3/8"H x 27 7/8"W x 20 11/16"D	120	\$2,247.00
70503120	HDDi-2B	Double Drawer	120V, 900W, 7.5 Amps	19 3/4"H x 27 7/8"W x 20 11/16"D	170	\$3,720.00
70503121	HDDi-2B	Double Drawer	208V, 900W, 4.3 Amps	19 3/4"H x 27 7/8"W x 20 11/16"D	170	\$3,720.00
70503122	HDDi-2B	Double Drawer	240V, 900W, 3.7 Amps	19 3/4"H x 27 7/8"W x 20 11/16"D	170	\$3,720.00
70503130	HDDi-3B	Triple Drawer	120V, 1350W, 11.3 Amps	29 1/8"H x 27 7/8"W x 20 11/16"D	220	\$5,173.00
70503131	HDDi-3B	Triple Drawer	208V, 1350W, 6.5 Amps	29 1/8"H x 27 7/8"W x 20 11/16"D	220	\$5,173.00
70503132	HDDi-3B	Triple Drawer	240V, 1350W, 5.6 Amps	29 1/8"H x 27 7/8"W x 20 11/16"D	220	\$5,173.00

X*PERT™ Series Slimline Built-In Holding Drawers

Slimline designed units that can be built directly into counters. Designed with a terminal block for easy wiring. Features Warming system, Heavy-Duty Stainless Steel construction, 6" pan, and moisture control vents. Drawer slides now feature the "Easy Roller" design that eliminates the problem of drawers jamming as you close them. Dimensions are base unit size, does not include the flange extensions. All models of HDDiS-B's cannot ship UPS. If shipping via air freight, dimensional weights apply. Backed by APW's One Year Warranty. FOB Standex Dock, freight class 100.



Part Number	Model	Description	Electric	Dimensions	Weight (lbs)	Price
70503310	HDDiS-1B	Single Drawer	120V, 450W, 3.8 Amps	11 3/8"H x 19 7/8"W x 28 7/8"D	120	\$2,247.00
70503311	HDDiS-1B	Single Drawer	208V, 450W, 2.1 Amps	11 3/8"H x 19 7/8"W x 28 7/8"D	120	\$2,247.00
70503312	HDDiS-1B	Single Drawer	240V, 450W, 1.8 Amps	11 3/8"H x 19 7/8"W x 28 7/8"D	120	\$2,247.00
70503320	HDDiS-2B	Double Drawer	120V, 900W, 7.5 Amps	21 1/4"H x 19 7/8"W x 28 7/8"D	170	\$3,720.00
70503321	HDDiS-2B	Double Drawer	208V, 900W, 4.3 Amps	21 1/4"H x 19 7/8"W x 28 7/8"D	170	\$3,720.00
70503322	HDDiS-2B	Double Drawer	240V, 900W, 3.7 Amps	21 1/4"H x 19 7/8"W x 28 7/8"D	170	\$3,720.00
70503330	HDDiS-3B	Triple Drawer	120V, 1350W, 11.3 Amps	31 1/8"H x 19 7/8"W x 28 7/8"D	220	\$5,126.00
70503331	HDDiS-3B	Triple Drawer	208V, 1350W, 6.5 Amps	31 1/8"H x 19 7/8"W x 28 7/8"D	220	\$5,126.00
70503332	HDDiS-3B	Triple Drawer	240V, 1350W, 5.6 Amps	31 1/8"H x 19 7/8"W x 28 7/8"D	220	\$5,126.00

Holding Drawer Options

Part Number	Model	Description	Price	
Leg and Caster Options				
0-999-002		5" Swivel caster kit	\$255.00	
33900		2" Swivel caster kit	\$255.00	
32010195		Spillage Pan	\$171.00	
Built-in Holding Drawer Cutout Dimensions				
		WIDTH	HEIGHT	DEPTH
	HDDi-1B	28 1/2"	10 3/4"	22"
	HDDi-2B	28 1/2"	20 3/8"	22"
	HDDi-3B	28 1/2"	29 5/8"	22"
	HDDiS-1B	20 1/2"	11 3/4"	30"
	HDDiS-2B	20 1/2"	21 5/8"	30"
	HDDiS-3B	20 1/2"	31 1/2"	30"

Lowerator® SERIES

Lowerator® Dispensers

APW Wyott Lowerators® provide sanitary, secure and concealed storage for plates, bowls and trays of all sizes. Easy to clean stainless surfaces and rugged, durable construction make these Lowerators® a smart investment for commercial serving centers of any size.

Drop-In Lowerator® Dispensers

208/240V units available. Please contact factory. Only HL- Models (shielded/heated) are CSA Certified and UL Listed. Accessories are available. Guides shown in picture are standard on L-12 model only. If shipping via air freight, dimensional weights apply. Backed by APW's One Year Warranty, FOB Standex Dock, freight class 150. Height 31 1/4"



Part Number	Model	Dish Size	Cut Out	Electric	Weight (lbs)	Price
Unshielded/Unheated						
20001200	L-5	Up to 5"	7 7/16"	N/A	10	\$721.00
20001300	L-6	5 1/8"-5 3/4"	8 3/16"	N/A	10	\$740.00
20001400	L-6.5	5 7/8"-6 1/2"	8 15/16"	N/A	11	\$798.00
20001500	L-7	6 5/8"-7 1/4"	9 11/16"	N/A	12	\$815.00
20001600	L-8	7 3/8"-8 1/8"	10 9/16"	N/A	15	\$894.00
20001700	L-9	8 1/4"-9 1/8"	11 9/16"	N/A	16	\$897.00
20001800	L-10	9 1/4"-10 1/8"	12 9/16"	N/A	17	\$906.00
20001900	L-12	10 1/4"-11 7/8"	14 5/16"	N/A	20	\$1,001.00
20001000	L-13	11 7/8"-13"	15 7/16"	N/A	21	\$1,280.00
Shielded/Unheated						
20002300	SL-5	Up to 5"	7 7/16"	N/A	15	\$921.00
20002400	SL-6	5 1/8"-5 3/4"	8 3/16"	N/A	16	\$966.00
20002500	SL-6.5	5 7/8"-6 1/2"	8 15/16"	N/A	17	\$1,003.00
20002600	SL-7	6 5/8"-7 1/4"	9 11/16"	N/A	18	\$1,036.00
20002700	SL-8	7 3/8"-8 1/8"	10 9/16"	N/A	24	\$1,154.00
20002800	SL-9	8 1/4"-9 1/8"	11 9/16"	N/A	24	\$1,166.00
20002900	SL-10	9 1/4"-10 1/8"	12 9/16"	N/A	24	\$1,178.00
20003000	SL-12	10 1/4"-11 7/8"	14 5/16"	N/A	30	\$1,416.00
20003200	SL-13	11 7/8"-13"	15 7/16"	N/A	32	\$1,559.00
Shielded/Heated						
20003400	HL-5	Up to 5"	7 7/16"	120V, 1.8 Amps	18	\$1,592.00
20003500	HL-6	5 1/8"-5 3/4"	8 3/16"	120V, 2.0 Amps	20	\$1,681.00
20003600	HL-6.5	5 7/8"-6 1/2"	8 15/16"	120V, 2.3 Amps	26	\$1,702.00
20003700	HL-7	6 5/8"-7 1/4"	9 11/16"	120V, 2.5 Amps	26	\$1,818.00
20003800	HL-8	7 3/8"-8 1/8"	10 9/16"	120V, 2.7 Amps	27	\$1,986.00
20003900	HL-9	8 1/4"-9 1/8"	11 9/16"	120V, 3.2 Amps	27	\$2,029.00
20004000	HL-10	9 1/4"-10 1/8"	12 9/16"	120V, 3.5 Amps	28	\$2,126.00
20004100	HL-12	10 1/4"-11 7/8"	14 5/16"	120V, 4.2 Amps	33	\$2,353.00
20004200	HL-13	11 7/8"-13"	15 7/16"	120V, 4.6 Amps	37	\$2,601.00
Options						
Dome Covers						
21782000		For L-5, SL-5, HL-5			12	\$231.00
21782100		For L-6, SL-6, HL-6			12	\$231.00
21782200		For L-6.5, SL-6.5, HL-6.5			12	\$231.00
21782300		For L-7, SL-7, HL-7			12	\$231.00
21782400		For L-8, SL-8, HL-8			12	\$231.00
21782500		For L-9, SL-9, HL-9			12	\$231.00
21782600		For L-10, SL-10, HL-10			12	\$231.00
21782800		For L-12, SL-12, HL-12			12	\$231.00
21782900		For L-13, SL-13, HL-13			12	\$231.00

Lowerator[®] SERIES

Drop-In Adjustube II Lowerator[®] Dispensers

Field adjustable weight and diameter. Dome covers are available for heated units, consult factory. Only heated units are CSA Certified and UL Listed. Accessories are available see below. If shipping via air freight, dimensional weights apply. Backed by APW's One Year Warranty. FOB Standex Dock, freight class 150. Height 31 1/4"



Part Number	Model	Dish Size	Cut Out	Electric	Weight (lbs)	Price
Unshielded/Unheated						
30011300	L-9A	3 1/2"-9 1/8"	11 9/16"	N/A	18	\$940.00
30011200	L-12A	9 1/4"-11 7/8"	14 5/16"	N/A	22	\$1,265.00
Shielded/Unheated						
30011100	SL-9A	3 1/2"-9 1/8"	11 9/16"	N/A	25	\$1,343.00
30011000	SL-12A	9 1/4"-11 7/8"	14 5/16"	N/A	31	\$1,601.00
Shielded/Heated						
30010000	HL-9A	3 1/2"-9 1/8"	11 9/16"	120V, 3.5 Amps	29	\$2,041.00
30009800	HL-12A	9 1/4"-11 7/8"	14 5/16"	120V, 4.2 Amps	37	\$2,384.00
Export Models: Shielded/Heated						
30010000	HL-9A	3 1/2"-9 1/8"	11 9/16"	240V, 1.6 Amps	29	\$2,041.00
30009800	HL-12A	9 1/4"-11 7/8"	14 5/16"	240V, 2.1 Amps	38	\$2,384.00
Options						
21782500		Dome covers for -9A			12	\$231.00
21782800		Dome covers for -12A			12	\$231.00
Contact CS	Shorten Tube	L Tube - 27 19/32" high				\$308.00
Contact CS	Shorten Tube	SL Tube - 27 13/16" high				\$450.00
Contact CS	Shorten Tube	HL Tube - 27 13/16" high				\$562.00

Trendline Mobile Adjustube II Lowerator[®] Dispensers

Mobile Dish Dispenser utilizes Adjustube II self-leveling tubes that are field adjustable for weight and diameter. Open type design reduces overall weight load. Tubular frame is welded construction. Supplied with non-marking 4" hard rubber casters and rear brakes. 208/240V units are available. Units are 36-7/8" high. Electrical information is based on heated items only and is non-applicable to unheated items. Only heated items are CSA Certified and UL Listed. All models cannot ship UPS. If shipping via air freight, dimensional weights apply. Backed by APW's One Year Warranty. FOB Standex Dock, freight class 85.



Part Number	Model	Dish Size	Cut Out	Electric	Weight (lbs)	Price
Unheated						
30035000	TL2-9A (not NSF)	3 1/2"-9 1/8"	33 1/2" x 17"	N/A	65	\$4,483.00
30035100	TL2-12A	9 1/4"-11 7/8"	33 1/2" x 17"	N/A	65	\$4,682.00
30035200	TL2-9A/12A (not NSF)	3 1/2"-9 1/8" (1 ea.) 9 1/4"-11 7/8" (1 ea.)	33 1/2" x 17"	N/A	65	\$4,645.00
Heated						
30035300	HTL2-9A	3 1/2"-9 1/8"	33 1/2" x 17"	6.33 Amps	88	\$4,682.00
30035400	HTL2-12A	9 1/4"-11 7/8"	33 1/2" x 17"	8.33 Amps	88	\$5,933.00
30035500	HTL2-9A/12A	3 1/2"-9 1/8" (1 ea.) 9 1/4"-11 7/8" (1 ea.)	33 1/2" x 17"	7.3 Amps	88	\$5,900.00
Options						
Contact CS	Model+ 5P	Standard unit with extra 5" polyurethane casters and 2 brakes packed in box (mobile units)			21	\$208.00
Contact CS	5RB	5" Rolling bumpers (For TL & HTL Series)			2	\$144.00

Lowerator[®]

SERIES

Drop-In Oval Lowerator[®] Dispensers

The APW Wyott Oval Dish Dispenser (OVD) is a self leveling dispenser for oval-shaped dinnerware. Tube construction is of stainless steel with polished flange and dispensing head. Four heavy-duty stainless steel guideposts ensure perfect positioning of leveled plates.

The dispensing mechanism in APW Wyott's Lowerators[®] uses springs attached to a sliding support bar that rides both inside and outside the tube. This design feature prevents a stack of dishware from sticking in the down position, and releasing unexpectedly. The OVD is field adjustable for weights up to 150 pounds. The flange supports the dispenser on the countertop after a hole cutout is made. Sample platter must accompany order.

NOTE: Please contact factory for ordering.



Trendline Mobile Lowerator[®] Dispensers

All items cannot ship UPS. Units are supplied with 4" non-marking, hard rubber casters and rear brakes. 208/240V units are available. Units are 36-7/8" high. Only heated items are CSA Certified and UL Listed. Accessories are available. Backed by APW's One Year Warranty. All items, FOB Standex Dock. If shipping via air freight, dimensional weights apply. FOB Standex Dock, freight class 85.



Part Number	Model	Dish Size	Cut Out	Electric	Weight (lbs)	Price
Two Tubes Unheated						
20020500	TL2-5	Up to 5"	24" x 12 1/2"	N/A	41	\$3,112.00
20020600	TL2-6	5 1/8"-5 3/4"	24" x 12 1/2"	N/A	43	\$3,127.00
20020700	TL2-6.5	5 7/8"-6 1/2"	24" x 12 1/2"	N/A	50	\$3,222.00
20020800	TL2-7	6 5/8"-7 1/4"	24" x 12 1/2"	N/A	57	\$3,351.00
20020900	TL2-8	7 3/8"-8 1/8"	30" x 15 1/2"	N/A	63	\$3,589.00
20021000	TL2-9	8 1/4"-9 1/8"	30" x 15 1/2"	N/A	69	\$3,793.00
20021100	TL2-10	9 1/4"-10 1/8"	30" x 15 1/2"	N/A	78	\$3,968.00
20021200	TL2-12	10 1/4"-11 7/8"	33 1/2" x 17"	N/A	92	\$4,305.00
20021400	TL2-13	11 7/8"-13"	35 3/4" x 17"	N/A	98	\$5,013.00
Two Tubes Heated						
20021600	HTL2-5	Up to 5"	24" x 12 1/2"	3.5 Amps	65	\$4,530.00
20021700	HTL2-6	5 1/8"-5 3/4"	24" x 12 1/2"	4.0 Amps	67	\$4,674.00
20021800	HTL2-6.5	5 7/8"-6 1/2"	24" x 12 1/2"	4.5 Amps	70	\$4,730.00
20021900	HTL2-7	6 5/8"-7 1/4"	24" x 12 1/2"	5.0 Amps	74	\$5,030.00
20022000	HTL2-8	7 3/8"-8 1/8"	30" x 15 1/2"	5.5 Amps	79	\$5,010.00
20022100	HTL2-9	8 1/4"-9 1/8"	30" x 15 1/2"	6.33 Amps	85	\$5,214.00
20022200	HTL2-10	9 1/4"-10 1/8"	30" x 15 1/2"	7.0 Amps	96	\$5,337.00
20022300	HTL2-12	10 1/4"-11 7/8"	33 1/2" x 17"	8.33 Amps	113	\$5,869.00
20022500	HTL2-13	11 7/8"-13"	35 3/4" x 17"	9.2 Amps	118	\$6,409.00
Three Tubes Unheated						
20044700	TL3-5	Up to 5"	30 1/2" x 12 1/2"	N/A	63	\$4,157.00
20044800	TL3-6	5 1/8"-5 3/4"	30 1/2" x 12 1/2"	N/A	65	\$4,240.00
20044900	TL3-6.5	5 7/8"-6 1/2"	35" x 15 1/2"	N/A	68	\$4,405.00
20045000	TL3-7	6 5/8"-7 1/4"	35" x 15 1/2"	N/A	81	\$4,578.00
20045100	TL3-8	7 3/8"-8 1/8"	41" x 17"	N/A	87	\$4,844.00
20045200	TL3-9	8 1/4"-9 1/8"	41" x 17"	N/A	97	\$5,019.00
20045300	TL3-10	9 1/4"-10 1/8"	44" x 17"	N/A	107	\$5,389.00
Three Tubes Heated						
20046800	HTL3-5	Up to 5"	30 1/2" x 12 1/2"	5.25 Amps	90	\$6,034.00
20046900	HTL3-6	5 1/8"-5 3/4"	30 1/2" x 12 1/2"	6.0 Amps	92	\$6,407.00
20047000	HTL3-6.5	5 7/8"-6 1/2"	35" x 15 1/2"	6.75 Amps	96	\$6,460.00
20047100	HTL3-7	6 5/8"-7 1/4"	35" x 15 1/2"	7.5 Amps	100	\$6,684.00
20047200	HTL3-8	7 3/8"-8 1/8"	41" x 17"	8.25 Amps	106	\$6,988.00
20047300	HTL3-9	8 1/4"-9 1/8"	41" x 17"	9.5 Amps	111	\$7,296.00
20047400	HTL3-10	9 1/4"-10 1/8"	44" x 17"	10.5 Amps	123	\$7,748.00
Options						
Contact CS	Model+ 5P	Standard unit with extra 5" polyurethane casters and 2 brakes packed in box (mobile units)			21	\$214.00
Contact CS	5RB	3" Rolling bumpers (For TL & HTL Series)			2	\$148.00

*See Terms and Conditions in price list for custom product policies on ordering Lowerators[®]

Lowerator[®]

SERIES

Enclosed Mobile Lowerator[®] Dispensers

All items cannot ship UPS. Units are supplied with standard non-marking 4" hard rubber casters, rear brakes and rubber bumper on all contact edges. 208/240V units available. Units are 36-9/16" high. Only heated items are CSA Certified and UL Listed. Accessories are available see below. If shipping via air freight, dimensional weights apply. Backed by APW's One Year Warranty. All items, FOB Standex Dock freight class 85.



Part Number	Model	Dish Size	Cut Out	Electric	Weight (lbs)	Price
Two Tubes Unheated						
20024000	ML2-5	Up to 5"	23 5/8" x 15 3/8"	N/A	92	\$4,164.00
20024100	ML2-6	5 1/8"-5 3/4"	23 5/8" x 15 3/8"	N/A	94	\$4,352.00
20024200	ML2-6.5	5 7/8"-6 1/2"	23 5/8" x 15 3/8"	N/A	95	\$4,374.00
20024300	ML2-7	6 5/8"-7 1/4"	23 5/8" x 15 3/8"	N/A	96	\$4,558.00
20024400	ML2-8	7 3/8"-8 1/8"	30 3/8" x 15 3/8"	N/A	98	\$4,632.00
20024500	ML2-9	8 1/4"-9 1/8"	30 3/8" x 15 3/8"	N/A	102	\$4,823.00
20024600	ML2-10	9 1/4"-10 1/8"	30 3/8" x 15 3/8"	N/A	104	\$5,035.00
20024700	ML2-12	10 1/4"-11 7/8"	32 7/8" x 17"	N/A	110	\$5,253.00
20024800	ML2-13	11 7/8" - 13"	35 1/8" x 18"	N/A	162	\$6,228.00
Two Tubes Heated						
20028400	HML2-5	Up to 5"	23 5/8" x 15 3/8"	3.5 Amps	106	\$5,888.00
20028500	HML2-6	5 1/8"-5 3/4"	23 5/8" x 15 3/8"	4.0 Amps	118	\$6,135.00
20028600	HML2-6.5	5 7/8"-6 1/2"	23 5/8" x 15 3/8"	4.5 Amps	119	\$6,163.00
20028700	HML2-7	6 5/8"-7 1/4"	23 5/8" x 15 3/8"	5.0 Amps	120	\$6,428.00
20028800	HML2-8	7 3/8"-8 1/8"	30 3/8" x 15 3/8"	5.5 Amps	122	\$6,290.00
20028900	HML2-9	8 1/4"-9 1/8"	30 3/8" x 15 3/8"	6.3 Amps	124	\$6,423.00
20029000	HML2-10	9 1/4"-10 1/8"	30 3/8" x 15 3/8"	7.0 Amps	150	\$6,517.00
20029100	HML2-12	10 1/4"-11 7/8"	32 7/8" x 17"	8.3 Amps	170	\$7,032.00
20029200	HML2-13	11 7/8" - 13"	35 1/8" x 18"	9.1 Amps	168	\$7,600.00
Three Tubes Unheated						
20025100	ML3-5	Up to 5"	30 3/8" x 17"	N/A	113	\$5,274.00
20025200	ML3-6	5 1/8"-5 3/4"	30 3/8" x 17"	N/A	115	\$5,570.00
20025300	ML3-6.5	5 7/8"-6 1/2"	34 5/8" x 17"	N/A	116	\$5,879.00
20025400	ML3-7	6 5/8"-7 1/4"	34 5/8" x 17"	N/A	117	\$6,165.00
20025500	ML3-8	7 3/8"-8 1/8"	40 1/4" x 18 7/8"	N/A	121	\$6,472.00
20025600	ML3-9	8 1/4"-9 1/8"	40 1/4" x 18 7/8"	N/A	126	\$6,684.00
20025700	ML3-10	9 1/4"-10 1/8"	43 1/4" x 18 7/8"	N/A	129	\$7,046.00
Three Tubes Heated						
20029500	HML3-5	Up to 5"	30 3/8" x 17"	5.3 Amps	147	\$7,306.00
20029600	HML3-6	5 1/8"-5 3/4"	30 3/8" x 17"	6.0 Amps	149	\$7,855.00
20029700	HML3-6.5	5 7/8"-6 1/2"	34 5/8" x 17"	6.8 Amps	150	\$7,949.00
20029800	HML3-7	6 5/8"-7 1/4"	34 5/8" x 17"	7.5 Amps	150	\$8,345.00
20029900	HML3-8	7 3/8"-8 1/8"	40 1/4" x 18 7/8"	8.3 Amps	151	\$8,702.00
20030000	HML3-9	8 1/4"-9 1/8"	40 1/4" x 18 7/8"	9.5 Amps	152	\$8,811.00
20030100	HML3-10	9 1/4"-10 1/8"	43 1/4" x 18 7/8"	10.5 Amps	153	\$9,049.00
Four Tubes Unheated						
20026200	ML4-5	Up to 5"	25 1/8" x 24 7/8"	N/A	131	\$6,654.00
20026300	ML4-6	5 1/8"-5 3/4"	25 1/8" x 24 7/8"	N/A	133	\$7,138.00
20026400	ML4-6.5	5 7/8"-6 1/2"	25 1/8" x 24 7/8"	N/A	135	\$7,382.00
20026500	ML4-7	6 5/8"-7 1/4"	25 1/8" x 24 7/8"	N/A	138	\$7,643.00
20026600	ML4-8	7 3/8"-8 1/8"	30 3/8" x 29 1/8"	N/A	144	\$8,101.00
20026700	ML4-9	8 1/4"-9 1/8"	30 3/8" x 29 1/8"	N/A	150	\$8,222.00
20026800	ML4-10	9 1/4"-10 1/8"	30 3/8" x 29 1/8"	N/A	152	\$8,571.00
Four Tubes Heated						
20030600	HML4-5	Up to 5"	25 1/8" x 24 7/8"	7.0 Amps	178	\$9,016.00
20030700	HML4-6	5 1/8"-5 3/4"	25 1/8" x 24 7/8"	8.0 Amps	180	\$9,608.00
20030800	HML4-6.5	5 7/8"-6 1/2"	25 1/8" x 24 7/8"	9.0 Amps	181	\$9,775.00
20030900	HML4-7	6 5/8"-7 1/4"	25 1/8" x 24 7/8"	10.0 Amps	182	\$10,041.00
20031000	HML4-8	7 3/8"-8 1/8"	30 3/8" x 29 1/8"	11.0 Amps	183	\$10,417.00
20031100	HML4-9	8 1/4"-9 1/8"	30 3/8" x 29 1/8"	12.7 Amps	183	\$10,518.00
20031200	HML4-10	9 1/4"-10 1/8"	30 3/8" x 29 1/8"	14.0 Amps	184	\$11,009.00
Options						
Contact CS	Model+ 5P	5" polyurethane casters			21	\$214.00

Price shown is for basic colors. (Custom colors, laminate options, and special finishes are extra, consult factory.)

Lowerator® SERIES

Enclosed Mobile Adjustube II Lowerator® Dispensers

Mobile Enclosed Cabinet-Style Dish Dispenser utilizes Adjustube II self-leveling tubes that are field adjustable for weight and diameter. Units are supplied with standard non-marking 4" hard rubber casters, rear brakes and contact edges are protected by heavy gauge stainless steel with rubber perimeter bumpers. 208/240V units are available. Units are 36 9/16" high. Electrical information is based on heated items only and is non-applicable to unheated items. Only heated items are CSA Certified and UL Listed. All models cannot ship UPS. If shipping via air freight, dimensional weights apply. Backed by APW's One Year Warranty. FOB Standex Dock, freight class 85.



Part Number	Model	Dish Size	Cut Out	Electric	Weight (lbs)	Price
Unheated Nsf						
30036000	ML2-9A	3 1/2"-9 1/8"	30 3/8" x 15 3/8"	N/A	104	\$6,303.00
30036100	ML2-12A	9 1/4"-12"	32 7/8" x 17"	N/A	110	\$7,770.00
30036200	ML2-9A/12A	3 1/2"-9 1/8" (1 ea.) 9 1/4"-12" (1 ea.)	32 7/8" x 17"	N/A	108	\$6,385.00
30036300	ML3-9A	3 1/2"-9 1/8"	40 1/4" x 18 7/8"	N/A	151	\$7,015.00
30036400	ML3-12A	9 1/4"-12"	48 1/4" x 18 7/8"	N/A	158	\$7,770.00
30036500	ML3-9A/9A/12A	3 1/2"-9 1/8" (2 ea.) 9 1/4"-12" (1 ea.)	48 1/4" x 18 7/8"	N/A	155	\$7,346.00
30036600	ML3-9A/12A/12A	3 1/2"-9 1/8" (1 ea.) 9 1/4"-12" (2 ea.)	48 1/4" x 18 7/8"	N/A	156	\$7,346.00
Heated (Csa And UL Only)						
30036700	HML2-9A	3 1/2"-9 1/8"	30 3/8" x 15 3/8"	6.3 Amps	128	\$7,770.00
30036800	HML2-12A	9 1/4"-12"	32 7/8" x 17"	8.3 Amps	134	\$9,052.00
30036900	HML2-9A/12A	3 1/2"-9 1/8" (1 ea.) 9 1/4"-12" (1 ea.)	32 7/8" x 17"	7.3 Amps	132	\$8,391.00
30037000	HML3-9A	3 1/2"-9 1/8"	40 1/4" x 18 7/8"	9.3 Amps	175	\$10,060.00
30037100	HML3-12A	9 1/4"-12"	48 1/4" x 18 7/8"	12.3 Amps	182	\$11,676.00
30037200	HML3-9A/9A/12A	3 1/2"-9 1/8" (2 ea.) 9 1/4"-12" (1 ea.)	48 1/4" x 18 7/8"	10.3 Amps	179	\$10,250.00
30037300	HML3-9A/12A/12A	3 1/2"-9 1/8" (1 ea.) 9 1/4"-12" (2 ea.)	48 1/4" x 18 7/8"	11.3 Amps	180	\$10,250.00
Options						
Contact CS	Model+ 5P	5" polyurethane casters			21	\$214.00

Price shown is for basic colors.
(Custom colors, laminate options, and special finishes are extra, consult factory.)

Drop-In Rack Lowerator® Dispensers

Drop-In Rack Dispensers use a self-leveling carrier mechanism to dispense cups, glasses or trays in a serving line or beverage service point. Easily installed by cutting an opening in countertop and dropping into place. Field adjustable for a wide range of loads. If shipping via air freight, dimensional weights apply. Backed by APW's One Year Warranty. FOB Standex Dock, freight class 150.



Part Number	Model	Tray Size	Cut Out	Weight (lbs)	Price
20007300	DI-1020	10" x 20"	24"W x 12 1/4"L	24	\$2,152.00
21104000	DI-1216	12" x 16"	20"W x 14"L	21	\$2,152.00
20007400	DI-1418	14" x 18"	22"W x 16 1/4"L	24	\$2,152.00
20007500	DI-1620	16" x 20"	24"W x 18 1/4"L	24	\$2,152.00
20007700	DI-2020	20" x 20"	24"W x 22 1/4"L	26	\$2,152.00
Options					
30040100	DIF-1020	10" x 20"		14	\$618.00
30040016	DIF-1216	12" x 16"		26	\$618.00
30040200	DIF-1418	14" x 18"		15	\$618.00
30040300	DIF-1620	16" x 20"		26	\$618.00
30040500	DIF-2020	20" x 20"		26	\$618.00

Lowerator[®] SERIES

Enclosed Mobile Combo Lowerator[®] Dispensers

Units are supplied with standard non-marking 4" hard rubber casters, rear brakes and rubber perimeter bumpers on all contact edges. Backed by APW's One Year Warranty. FOB Standex Dock, freight class 85.



Part Number	Model	Tray Size	Saucer Size	Dimensions	Weight (lbs)	Price
Unheated (NSF only)						
20041000	MCTRS-2020-5	20" x 20"	Up to 5"	36"H x 24"W x 40 3/8"L	247	\$7,004.00
20041100	MCTRS-2020-6	20" x 20"	5 1/8" to 5 3/4"	36"H x 24"W x 40 3/8"L	247	\$7,004.00
20041200	MCTRS-2020-6.5	20" x 20"	5 7/8" to 6 1/2"	36"H x 24"W x 40 3/8"L	247	\$7,004.00
Add 3 3/4" to height for guide posts.						
Options						
Contact CS	Model+ 5P	5" polyurethane casters			21	\$214.00

Price shown is for basic colors.
(Custom colors, laminate options, and special finishes are extra, consult factory.)

Enclosed Mobile Cantilever Lowerator[®] Dispensers

Enclosed, self-leveling, accommodates two stacks of plates in addition to trays or racks through the use of drop-in dish dispensers. Units are supplied with standard non-marking 4" hard rubber casters, rear brakes and rubber perimeter bumpers on all contact edges. Accessories are available see below. If shipping via air freight, dimensional weights apply. Backed by APW's One Year Warranty. FOB Standex Dock, freight class 85.



Part Number	Model	Tray Size	Dimensions	Weight (lbs)	Price
Unheated (NSF only)					
20068000	MCTR-1020	10" x 20"	36"H x 24"W x 20 1/4"L	160	\$5,300.00
20067500	MCTR-1418	14" x 18"	36"H x 18"W x 28 1/4"L	160	\$5,300.00
20067800	MCTR-1616	16" x 16"	36"H x 20 1/4"W x 26 1/2"L	175	\$5,300.00
20067900	MCTR-1620	16" x 20"	36"H x 20 1/4"W x 30 1/2"L	180	\$5,300.00
20067700	MCTR-1622	16" x 22"	36"H x 20 1/4"W x 32 1/4"L	180	\$5,300.00
20068100	MCTR-2020	20" x 20"	36"H x 24"W x 30 1/4"L	204	\$5,300.00
Options					
Contact CS	Model+ 5P	5" polyurethane casters		21	\$214.00

Price shown is for basic colors.
(Custom colors, laminate options, and special finishes are extra, consult factory.)

Open Mobile Combo Lowerator[®] Dispensers

Self-leveling dispenser, that is easily field adjustable for dispensing racks of cups with Adjustube dispensers for dispensing saucers. Dependable, adjustable spring dispensing mechanism. Standard with four rubber corner bumpers and non-marking 4" hard rubber casters with rear brakes. Capacity: to 125 trays, 14 dozen cups, 16 dozen glasses and 12 dozen saucers. If shipping via air freight, dimensional weights apply. Backed by APW's One Year Warranty. FOB Standex Dock, freight class 85.



Part Number	Model	Tray Size	Saucer Size	Dimensions	Weight (lbs)	Price
20068900	CTRS-2020-5 (NSF only)	20" x 20"	Up to 5"	36"H x 22 11/16"W x 38 15/16"L	199	\$7,004.00
20061500	CTRS-2020-6 (NSF only)	20" x 20"	5 1/8" to 5 3/4"	36"H x 22 11/16"W x 38 15/16"L	199	\$7,004.00
20061600	CTRS-2020-6.5 (NSF only)	20" x 20"	5 7/8" to 6 1/2"	36"H x 22 11/16"W x 38 15/16"L	199	\$7,004.00
Options						
Contact CS	Model+ 5P	Standard unit with extra 5" polyurethane casters and 2 brakes packed in box (mobile units)			21	\$214.00
Contact CS	PB	Perimeter bumpers			18	\$248.00

Lowerator® SERIES

Open Mobile Cantilever Lowerator® Dispensers

Units are supplied standard with four rubber corner bumpers and non-marking 4" hard rubber casters with rear brakes. Capacity: to 125 trays, 14 dozen cups, 16 dozen glasses, 12 dozen saucers. Cannot ship UPS. Approvals on heated units only. If shipping via air freight, dimensional weights apply. Backed by APW's One Year Warranty. FOB Standex Dock, freight class 85.



Part Number	Model	Tray Size	Dimensions	Weight (lbs)	Price
20037700	CTR-1014	10" x 14"	36"H x 18 11/16"W x 21 7/8"L	108	\$4,066.00
20038100	CTR-1020 (NSF)	10" x 20"	36"H x 22 11/16"W x 21 7/8"L	110	\$4,066.00
20037800	CTR-1418	14" x 18"	36"H x 18 11/16"W x 29 7/8"L	110	\$4,066.00
20038000	CTR-1620	16" x 20"	36"H x 18 11/16"W x 32 1/8"L	110	\$4,066.00
20038300	CTR-1622	16" x 22"	36"H x 18 11/16"W x 33 7/8"L	110	\$4,066.00
20038200	CTR-2020	20" x 20"	36"H x 22 11/16"W x 31 7/8"L	118	\$4,066.00

Double Open Mobile Cantilever Lowerator® Dispensers

Units are supplied standard with non-marking 4" hard rubber casters. Backed by APW's One Year Warranty. FOB Standex Dock, freight class 85.



Part Number	Model	Tray Size	Dimensions	Weight (lbs)	Price
21800000	CTRD-1014	10" x 14"	36"H x 36"W x 22"L	225	\$5,935.00
21800200	CTRD-1418	14" x 18"	36"H x 36"W x 30"L	231	\$5,935.00
21800300	CTRD-1620	16" x 20"	36"H x 36"W x 32"L	232	\$5,935.00
21800500	CTRD-1622	16" x 22"	36"H x 36"W x 34"L	236	\$5,935.00
Options					
Contact CS	Model+ 5P	Standard unit with extra 5" polyurethane casters and 2 brakes packed in box (mobile units)		21	\$214.00

Custom sizes are available. Consult factory for price quote

Index

A	CTRD-1622	69	FACW-5	43	FDDC-72L	49	FT-1000	18	HDDI-3B	62	
APW-F15C	6	CTRS-2020-5	68	FACW-6	43	FDDL-18H	58	FT-1000H	18	HDDIS-1	61
APW-F25C	6	CTRS-2020-6	68	FD-18H	52	FDDL-18L	59	FW-2026	40	HDDIS-1B	62
AT EXPRESS	17	CTRS-2020-6.5	68	FD-18L	53	FDDL-24H	58	FW-2026D	40	HDDIS-2	61
B	CW-1	42	FD-24H	52	FDDL-24L	59	G				
BC-20	30	CW-1B	21	FD-24L	53	FDDL-30H	58	GCB-18i	1	HDDIS-2B	62
BC-31	30	CW-2	42	FD-30H	52	FDDL-30L	59	GCB-18i-CE	1	HDDIS-3	61
BC-31D	30	CW-2Ai	21	FD-30L	53	FDDL-36H	58	GCB-24i	1	HDDIS-3B	62
BC-50	30	CW-3	42	FD-36H	52	FDDL-36L	59	GCB-24i-CE	1	HDS-24C	16
BC-50D	30	CW-3A	21	FD-36L	53	FDDL-42H	58	GCB-36i	1	HDS-24L	16
BM-30	39	CW-4	42	FD-42H	52	FDDL-42L	59	GCB-36i-CE	1	HDS-36C	16
BM-30 UL	40	CW-5	42	FD-42L	53	FDDL-48H	58	GCB-48i	1	HDS-36L	16
BM-30D	39	CW-6	42	FD-48H	52	FDDL-48L	59	GCB-48i-CE	1	HDS-48C	16
BM-30D UL	40	CWC-2	42	FD-48L	53	FDDL-54H	58	GCRB-18i	1	HDS-48L	16
BM-80	39	CWC-3	42	FD-54H	52	FDDL-54L	59	GCRB-18i-CE	1	HDS-60C	16
BM-80 UL	40	CWC-4	42	FD-54L	53	FDDL-60H	58	GCRB-24i	1	HDS-60L	16
BM-80C	39	CWC-5	42	FD-60H	52	FDDL-60L	59	GCRB-24i-CE	1	HDS-72C	16
BM-80C UL	40	CWK-1 pkg	20	FD-60L	53	FDDL-66H	58	GCRB-36i	1	HDS-72L	16
BM-80CD	39	CWM-2A	22	FD-66H	52	FDDL-66L	59	GCRB-36i-CE	1	HDXI-1	61
BM-80CD UL	40	CWM-2SP	22	FD-66L	53	FDDL-72H	58	GCRB-48i	1	HDXI-2	61
BM-80D	39	CWM-2V	22	FD-72H	52	FDDL-72L	59	GCRB-48i-CE	1	HDXI-3	61
BM-80D UL	40	D		FD-72L	53	FDDL-18H	50	GFT-31	43	HDXI-4	61
BT-15-2	18	DI-1020	67	FDC-18H	44	FDDL-18L	51	GFT-45	43	HEF-15Si	16
BT-15-2 CE	18	DI-1216	67	FDC-18L	45	FDDL-24H	50	GFT-59	43	HEF-30Ti	16
BT-15-3	18	DI-1418	67	FDC-24H	44	FDDL-24L	51	GFT-73	43	HF-1	34
BT-15-3 CE	18	DI-1620	67	FDC-24L	45	FDDL-30H	50	GFT-78i	2	HF-12	37
BW-20	30	DI-2020	67	FDC-30H	44	FDDL-30L	51	GGM-18i	2	HF-12D	37
BW-31	30	DIF-1014	67	FDC-30L	45	FDDL-36H	50	GGM-18i-CE	2	HF-1D	34
BW-50	30	DIF-1020	67	FDC-36H	44	FDDL-36L	51	GGM-24i	2	HF-2	34
BWD-31	31	DIF-1216	67	FDC-36L	45	FDDL-42H	50	GGM-24i-CE	2	HF-23	37
BWD-45	31	DIF-1418	67	FDC-42H	44	FDDL-42L	51	GGM-36i	2	HF-23D	37
BWD-50	31	DIF-1620	67	FDC-42L	45	FDDL-48H	50	GGM-36i-CE	2	HF-2D	34
BWD-75	31	DIF-1622	67	FDC-48H	44	FDDL-48L	51	GGM-48i	2	HF-3	34
BWD-75N	31	DIF-2020	67	FDC-48L	45	FDDL-54H	50	GGM-48i-CE	2	HF-3D	34
C		DMXD-30H	33	FDC-54H	44	FDDL-54L	51	GGT-18i	2	HF-4	34
CDO-18	7	DMXD-30S	33	FDC-54L	45	FDDL-60H	50	GGT-18i-CE	2	HF-43D	37
CDO-18B	7	DMXD-36H	33	FDC-60H	44	FDDL-60L	51	GGT-24i	2	HF-4D	34
CFHS-16	24	DMXD-36S	33	FDC-60L	45	FDDL-66H	50	GGT-24i-CE	2	HF-5	34
CFHS-21	24	DMXD-42H	33	FDC-66H	44	FDDL-66L	51	GGT-36i	2	HF-5D	34
CFW-1	43	DMXD-42S	33	FDC-66L	45	FDDL-72H	50	GGT-36i-CE	2	HF-6	34
CFW-1D	43	DMXD-48H	33	FDC-72H	44	FDDL-72L	51	GGT-48i	2	HF-6D	34
CFW-43	43	DMXD-48S	33	FDC-72L	45	FDL-18H	54	GGT-48i-CE	2	HF-6D	34
CFW-43D	43	DMXD-54H	33	FDD-18H	56	FDL-18L	55	GHP-2i	3	HF-6D	34
CH-11D	39	DMXD-54S	33	FDD-18L	57	FDL-24H	54	GHP-2i-CE	3	HF-6D	34
CHDT-2	41	DMXD-60H	33	FDD-24H	56	FDL-24L	55	GHP-4i	3	HF-6D	34
CHDT-3	41	DMXD-60S	33	FDD-24L	57	FDL-30H	54	GHP-4i-CE	3	HF-6D	34
CHDT-4	41	DMXS-30H	33	FDD-30H	56	FDL-30L	55	GHP-6i	3	HF-6D	34
CHDT-5	41	DMXS-30S	33	FDD-30L	57	FDL-36H	54	GHP-6i-CE	3	HF-6D	34
CHDT-6	41	DMXS-36H	33	FDD-36H	56	FDL-36L	55	GHP-2i-CE	4	HF-6D	34
CHP-1A	4	DMXS-36S	33	FDD-36L	57	FDL-42H	54	GHP-4i	3	HF-6D	34
CMC-24	6	DMXS-42H	33	FDD-42H	56	FDL-42L	55	GHP-4i-CE	3	HF-6D	34
CMC-36	6	DMXS-42S	33	FDD-42L	57	FDL-48H	54	GHP-6i	3	HF-6D	34
CMC-48	6	DMXS-48H	33	FDD-48H	56	FDL-48L	55	GHP-6i-CE	3	HF-6D	34
CMP-24	6	DMXS-48S	33	FDD-48L	57	FDL-54H	54	GHP-2i	3	HF-6D	34
CMP-36	6	DMXS-54H	33	FDD-54H	56	FDL-54L	55	GHP-2i-CE	4	HF-6D	34
CMP-48	6	DMXS-54S	33	FDD-54L	57	FDL-60H	54	GHP-2i	3	HF-6D	34
CMW-24	6	DMXS-60H	33	FDD-60H	56	FDL-60L	55	GHP-2i-CE	4	HF-6D	34
CMW-36	6	DMXS-60S	33	FDD-60L	57	FDL-66H	54	GHP-2i	3	HF-6D	34
CMW-48	6	DS-1A	31	FDD-66H	56	FDL-66L	55	GHP-2i-CE	4	HF-6D	34
COMP-5	42	DS-1AP	31	FDD-66L	57	FDL-72H	54	GHP-2i	3	HF-6D	34
COV	18	DW-1A	24	FDD-72H	56	FDL-72L	55	GHP-2i-CE	3	HF-6D	34
CP-1A	4	DWCI-14	32	FDD-72L	57	FDLC-18H	46	GHP-2i	3	HF-6D	34
CP-2A	4	E		FDDC-18H	48	FDLC-18L	47	GHP-2i-CE	4	HF-6D	34
CT-2	12	ECO4000 350E	17	FDDC-18L	49	FDLC-24H	46	GHP-2i	3	HF-6D	34
CT-2S	12	ECO4000 350L	17	FDDC-24H	48	FDLC-24L	47	GHP-2i-CE	4	HF-6D	34
CT-3	12	ECO4000 500E	17	FDDC-24L	49	FDLC-30H	46	GHP-2i	3	HF-6D	34
CT-3S	12	ECO4000 500L	17	FDDC-30H	48	FDLC-30L	47	GHP-2i-CE	4	HF-6D	34
CT-4	12	EF-15iN	7	FDDC-30L	49	FDLC-36H	46	GHP-2i	3	HF-6D	34
CT-4S	12	EF-30i	7	FDDC-36H	48	FDLC-36L	47	GHP-2i-CE	4	HF-6D	34
CT-5	12	EF-30iNT	7	FDDC-36L	49	FDLC-42H	46	GHP-2i	3	HF-6D	34
CT-5S	12	EG-24i	3	FDDC-42H	48	FDLC-42L	47	GHP-2i-CE	4	HF-6D	34
CTCW-43	32	EG-24i-CE	3	FDDC-42L	49	FDLC-48H	46	GHP-2i	3	HF-6D	34
CTR-1014	69	EG-36i	3	FDDC-48H	48	FDLC-48L	47	GHP-2i-CE	4	HF-6D	34
CTR-1020	69	EG-36i-CE	3	FDDC-48L	49	FDLC-54H	46	GHP-2i	3	HF-6D	34
CTR-1418	69	EG-48i	3	FDDC-54H	48	FDLC-54L	47	GHP-2i-CE	4	HF-6D	34
CTR-1620	69	EG-48i-CE	3	FDDC-54L	49	FDLC-60H	46	GHP-2i	3	HF-6D	34
CTR-1622	69	EHPi	4	FDDC-60H	48	FDLC-60L	47	GHP-2i-CE	4	HF-6D	34
CTR-2020	69	F		FDDC-60L	49	FDLC-66H	46	GHP-2i	3	HF-6D	34
CTRD-1014	69	FACW-2	47	FDDC-66H	48	FDLC-66L	47	GHP-2i-CE	4	HF-6D	34
CTRD-1418	69	FACW-3	43	FDDC-66L	49	FDLC-72H	46	GHP-2i	3	HF-6D	34
CTRD-1620	69	FACW-4	43	FDDC-72H	48	FDLC-72L	47	GHP-2i-CE	4	HF-6D	34
								GHP-2i	3	HF-6D	34
								GHP-2i-CE	4	HF-6D	34
								GHP-2i	3	HF-6D	34
								GHP-2i-CE	4	HF-6D	34
								GHP-2i	3	HF-6D	34
								GHP-2i-CE	4	HF-6D	34
								GHP-2i	3	HF-6D	34
								GHP-2i-CE	4	HF-6D	34
								GHP-2i	3	HF-6D	34
								GHP-2i-CE	4	HF-6D	34
								GHP-2i	3	HF-6D	34
								GHP-2i-CE	4	HF-6D	34
								GHP-2i	3	HF-6D	34
								GHP-2i-CE	4	HF-6D	34
								GHP-2i	3	HF-6D	34
								GHP-2i-CE	4	HF-6D	34
								GHP-2i	3	HF-6D	34
								GHP-2i-CE	4	HF-6D	34
								GHP-2i	3	HF-6D	34
								GHP-2i-CE	4	HF-6D	34
								GHP-2i	3	HF-6D	34
								GHP-2i-CE	4	HF-6D	34
								GHP-2i	3	HF-6D	34
								GHP-2i-CE	4	HF-6D	34
								GHP-2i	3	HF-6D	34
								GHP-2i-CE	4	HF-6D	34
								GHP-2i	3	HF-6D	34
								GHP-2i-CE	4	HF-6D	34
								GHP-2i	3	HF-6D	34
								GHP-2i-CE	4	HF-6D	34
								GHP-2i	3	HF-6D	34

Index

HMG-2460i.....15	HTG-2460i.....15	ML3-12A.....67	PWT-5.....12	SST-120-3S.....10	W-3Vi-CE.....21
HMG-2472i.....15	HTG-2472i.....15	ML3-5.....66	PWT-5S.....12	SST-120-4.....10	W-43V.....21
HML2-10.....66	HTL2-10.....65	ML3-6.....66	R	SST-120-4S.....10	W-43V-CE.....21
HML2-12.....66	HTL2-12.....65	ML3-6.5.....66	RCW-11.....20	SST-120-5.....10	W-4B.....23
HML2-12A.....67	HTL2-12A.....64	ML3-7.....66	RCW-11SP.....20	SST-120-5S.....10	W-4B PKG.....23
HML2-13.....66	HTL2-13.....65	ML3-8.....66	RCW-7.....20	SST-208-2.....10	W-4B PKG (ULSAN).....23
HML2-5.....66	HTL2-5.....65	ML3-9.....66	RCW-7SP.....20	SST-208-2S.....10	W-6.....23
HML2-6.....66	HTL2-6.....65	ML3-9A.....67	Roller Grills.....26-28	SST-208-3.....10	W-9.....23
HML2-6.5.....66	HTL2-6.5.....65	ML3-9A/12A/12A.....67	RTR-4.....31	SST-208-3S.....10	W-9iSP.....22
HML2-7.....66	HTL2-7.....65	ML3-9A/9A/12A.....67	RTR-4Di.....32	SST-208-4.....10	W-9iSP2.....22
HML2-8.....66	HTL2-8.....65	ML4-10.....66	RTR-8.....31	SST-208-4S.....10	W-9iSP3.....22
HML2-9.....66	HTL2-9.....65	ML4-5.....66	RW-1V.....20	SST-208-5.....10	W4-2.....22
HML2-9A.....67	HTL2-9A.....64	ML4-6.....66	RW-1V-SP.....20	SST-208-5S.....10	WGST-2.....11
HML2-9A/12A.....67	HTL2-9A/12A.....64	ML4-6.5.....66	RW-2V.....20	SST-240-2.....10	WGST-2S.....11
HML3-10.....66	HTL3-10.....65	ML4-7.....66	RW-2V-SP.....20	SST-240-2S.....10	WGST-3.....11
HML3-12A.....67	HTL3-5.....65	ML4-8.....66	S	SST-240-3.....10	WGST-3S.....11
HML3-5.....66	HTL3-6.....65	ML4-9.....66	SBW-120.....31	SST-240-3S.....10	WGST-4.....11
HML3-6.....66	HTL3-6.5.....65	P	SEHPi.....4	SST-240-4.....10	WGST-4S.....11
HML3-6.5.....66	HTL3-7.....65	PB.....68	SFT-31.....43	SST-240-4S.....10	WGST-5.....11
HML3-7.....66	HTL3-8.....65	PCT-2.....12	SFT-45.....43	SST-240-5.....10	WGST-5S.....11
HML3-8.....66	HTL3-9.....65	PCT-2S.....12	SFT-59.....43	SST-240-5S.....10	WK-1V PKG.....20
HML3-9.....66	I	PCT-3.....12	SFT-73.....43	ST-120-2.....9	Wok-Ring.....3
HML3-9A.....67	IBB-05F.....5	PCT-3S.....12	SFT-87.....43	ST-120-2S.....9	WS-2.....25
HML3-9A/12A/12A.....67	ICP-100.....42	PCT-4.....12	SG-20.....29	ST-120-3.....9	WS-3.....25
HML3-9A/9A/12A.....67	ICP-200.....42	PCT-4S.....12	SG-31.....29	ST-120-3S.....9	WS-4.....25
HML4-10.....66	ICP-300.....42	PCT-5.....12	SG-31XP.....29	ST-120-4.....9	WS-5.....25
HML4-5.....66	ICP-400.....42	PCT-5S.....12	SG-45DD.....29	ST-120-4S.....9	WS-6.....25
HML4-6.....66	ICP-500.....42	PD-1A.....24	SG-50.....29	ST-120-5.....9	WT-3.....12
HML4-6.5.....66	ICP-600.....42	PS0019.....19	SG-50XP.....29	ST-120-5S.....9	WT-3S.....12
HML4-7.....66	ICPC-200.....42	PSST-120-2.....10	SG-75/85.....29	ST-208-2.....9	WT-4.....12
HML4-8.....66	ICPC-300.....42	PSST-120-2S.....10	SG-75/85XP.....29	ST-208-2S.....9	WT-4S.....12
HML4-9.....66	ICPC-400.....42	PSST-120-3.....10	SG-75W.....29	ST-208-3.....9	WT-5.....12
HR-20.....26	ICPC-500.....42	PSST-120-3S.....10	SHFWEZ-2D.....36	ST-208-3S.....9	WT-5S.....12
HR-20S.....26	ICPN-200.....42	PSST-120-4.....10	SHFWEZ-3D.....36	ST-208-4.....9	X
HR-31.....26, 27	ICPN-300.....42	PSST-120-4S.....10	SHFWEZ-4D.....36	ST-208-4S.....9	XTREME Toasters.....17, 18
HR-31BC.....27	ICT-18A.....5	PSST-120-5.....10	SHFWEZ-5D.....36	ST-208-5.....9	XTRM-1.....17
HR-31BD.....28	IHP-1.....5	PSST-120-5S.....10	SHFWEZ-6D.....36	ST-208-5S.....9	XTRM-2.....18
HR-31BW.....28	IHP-2.....5	PSST-208-2.....10	SL-10.....63	ST-240-2.....9	XTRM-2H.....18
HR-31S.....26, 27	IHP-4.....5	PSST-208-2S.....10	SL-12.....63	ST-240-2S.....9	XTRM-3.....18
HR-31SBC.....27	IWK-1.....5	PSST-208-3.....10	SL-12A.....64	ST-240-3.....9	XTRM-3H.....18
HR-31SBD.....28	L	PSST-208-3S.....10	SL-13.....63	ST-240-3S.....9	
HR-31SBW.....28	L-10.....63	PSST-208-4.....10	SL-5.....63	ST-240-4.....9	
HR-45.....26	L-12.....63	PSST-208-4S.....10	SL-6.....63	ST-240-4S.....9	
HR-50.....26, 27	L-12A.....64	PSST-208-5.....10	SL-6.5.....63	ST-240-5.....9	
HR-50BC.....27	L-13.....63	PSST-208-5S.....10	SL-7.....63	ST-240-5S.....9	
HR-50BD.....28	L-5.....63	PSST-240-2.....10	SL-8.....63	T	
HR-50BW.....28	L-6.....63	PSST-240-2S.....10	SL-9.....63	TG-2025.....8	
HR-50S.....26, 27	L-6.5.....63	PSST-240-3.....10	SL-9A.....64	TL2-10.....65	
HR-50SBC.....27	L-7.....63	PSST-240-3S.....10	SM-50-11.....38	TL2-12.....65	
HR-50SBD.....28	L-8.....63	PSST-240-4.....10	SM-50-11 UL.....38	TL2-12A.....64	
HR-50SBW.....28	L-9.....63	PSST-240-4S.....10	SM-50-11D.....38	TL2-13.....65	
HR-75.....26, 27	L-9A.....64	PSST-240-5.....10	SM-50-11D UL.....38	TL2-5.....65	
HR-85.....26	M	PSST-240-5S.....10	SM-50-4.....38	TL2-6.....65	
HRDI-31s.....28	M-2000.....19	PST-120-2.....9	SM-50-4 UL.....38	TL2-6.5.....65	
HRDI-50S.....28	M-83.....19	PST-120-2S.....9	SM-50-4D.....38	TL2-7.....65	
HRS-20.....26	M-95-2.....19	PST-120-3.....9	SM-50-4D UL.....38	TL2-8.....65	
HRS-20S.....26	M-95-2 Low Profile.....19	PST-120-3S.....9	SM-50-7.....38	TL2-9.....65	
HRS-31.....26, 27	M-95-3.....19	PST-120-4.....9	SM-50-7 UL.....38	TL2-9A.....64	
HRS-31BC.....27	M-95-3FC-CE.....19	PST-120-4S.....9	SM-50-7D.....38	TL2-9A/12A.....64	
HRS-31BD.....28	MCTR-1020.....68	PST-120-5.....9	SM-50-7D UL.....38	TL3-10.....65	
HRS-31BW.....28	MCTR-1418.....68	PST-120-5S.....9	SM-50-EZ-11D.....38	TL3-5.....65	
HRS-31S.....26, 27	MCTR-1616.....68	PST-208-2.....9	SM-50-EZ-7D.....38	TL3-6.....65	
HRS-31SBC.....27	MCTR-1620.....68	PST-208-2S.....9	SPTU-30.....30	TL3-6.5.....65	
HRS-31SBD.....28	MCTR-1622.....68	PST-208-3.....9	SPTU-30N.....30	TL3-7.....65	
HRS-31SBW.....28	MCTR-2020.....68	PST-208-3S.....9	SPTU-50.....30	TL3-8.....65	
HRS-45.....26	MCTRS-2020-5.....68	PST-208-4.....9	SPTU-50N.....30	TL3-9.....65	
HRS-50.....26, 27	MCTRS-2020-6.....68	PST-208-4S.....9	SSS-18C.....8	TL3-9.....65	
HRS-50BC.....27	MCTRS-2020-6.5.....68	PST-208-5.....9	SSS-18L.....8	TM-12L.....37	
HRS-50BD.....28	ML2-10.....66	PST-208-5S.....9	SSS-24C.....8	TM-12L UL.....37	
HRS-50BW.....28	ML2-12.....66	PST-240-2.....9	SSS-24L.....8	TM-12LD.....37	
HRS-50S.....26, 27	ML2-12A.....67	PST-240-2S.....9	SSS-36C.....8	TM-12LD UL.....37	
HRS-50SBC.....27	ML2-13.....66	PST-240-3.....9	SSS-36L.....8	TM-43.....37	
HRS-50SBD.....28	ML2-5.....66	PST-240-3S.....9	SSS-48C.....8	TM-43 UL.....37	
HRS-50SBW.....28	ML2-6.....66	PST-240-4.....9	SSS-48L.....8	TM-43D.....37	
HRS-75.....26, 27	ML2-6.5.....66	PST-240-4S.....9	SSS-60C.....8	TM-43D UL.....37	
HRS-85.....26	ML2-7.....66	PST-240-5.....9	SSS-60L.....8	TM-90.....37	
HRSDI-31S.....28	ML2-8.....66	PST-240-5S.....9	SSS-72C.....8	TM-90 UL.....36	
HRSDI-50S.....28	ML2-9.....66	PWT-3.....12	SSS-72L.....8	TM-90D.....37	
HTG-2424i.....15	ML2-9A.....67	PWT-3S.....12	SST-120-2.....10	TM-90D UL.....36	
HTG-2436i.....15	ML2-9A/12A.....67	PWT-4.....12	SST-120-2S.....10	W	
HTG-2448i.....15	ML3-10.....66	PWT-4S.....12	SST-120-3.....10	W-12.....23	
				W-3Vi.....21	

Enhanced Warranty



For Equipment Covered by APW Wyott's "Enhanced Warranty" Program—if within one year from date of purchase this unit fails to function, you are entitled to your choice of 1, 2, or 3. The Enhanced Warranty Program applies to Models W-3Vi, W-4B, W4-2, RW-1V, RW-2V, RCW-11, CW-2Ai, CW-3A, CHP-1A

On All Calls, You Need To Give The Following Information:

1. Name and title of person calling
2. Phone number of person calling
3. Business name
4. Street address
5. City, State, Zip
6. Model, Serial Numbers (From serial plate)
7. Date purchased (if serial number indicates date of manufacture is over 13 months old, you will be asked to supply proof of purchase)

For Shortage – Supply the Above Information and Fully Explain What Is Missing

It will be sent immediately – prepaid via UPS or equivalent.

(Next Day Air or Priority shipments available at customer's expense)

1. APW Wyott will replace the unit. When calling the factory, besides the above information, you will need electrical characteristics, voltage and phase; describe the problem the best you can. The factory will require a Visa or MasterCard number and expiration date of same to assure return and/or validity of condition. Upon validation of credit card information, factory will strive to ship a replacement unit the same day if call is received before 3 p.m. Central Time or the next day if later. The replacement unit will be shipped prepaid regular UPS or equivalent. If requested Next Day Air or Priority, shipment will be made at customer's expense. Upon receipt, it is the customer's responsibility to unpack the new unit, taking care to preserve the packaging. Repack the unit being replaced in the same container, using caution to pack properly, and return this unit to the factory following the instruction supplied. Factory will supply return level and UPS call tag, both must be used. If original unit is returned within 30 days and is represented, the credit card validation will be cancelled.

IMPORTANT: If factory does not receive the unit to be returned within 30 days, the unit will be billed to the credit card number supplied. If the returned unit is not as represented – i.e. out of warranty, customer abuse, then it will be billed to the credit card number supplied. In these cases, the person calling in the problem will be contacted and, if applicable, the returned unit, if charged for will be returned to the original owner if requested.

2. You may take this unit to the APW Wyott Authorized Service Distributor. List of same is included with each product. If the problem is covered under warranty, the unit will be repaired at no cost to you. If the Authorized Agency cannot repair same within a reasonable time while you wait, it will be returned to you prepaid, via UPS.
3. You can request the Authorized Service Distributor to service the equipment on site. If problem is covered under the warranty, the parts and labor will be billed to the factory, while the mileage and travel time will be the responsibility of the owner.

24-Hour Service Hotline: 1-800-733-2203

The replacement warranty is only available on selected products shipped within the continental USA, Alaska, Hawaii, and Canada. As with most warranties, warranty is only valid to the original end-user/owner. Instructions and procedures must be followed or the warranty is void.

Terms & Conditions

1. Quotations

Quotations submitted by Seller (also referred to as "APW Wyott") are good for acceptance only within sixty (60) days from date of quotation for shipments within six (6) months. For shipments beyond 6 months from date of quotation, add 1% per month for a maximum of an additional two (2) months. This escalator is a maximum. If the current price at time of shipment is lower, it will apply. Quotations will be submitted on request for delivery requirements up to eighteen (18) months. Prices quoted do not include any sales, use, and excise, occupational or other similar tax. Delivery lead times contained within quotations shall date from receipt by Seller of all necessary engineering and manufacturing information, including approved drawings, if required by Buyer.

2. Acceptance/Minimum Order

\$5,000 Initial Order. All orders are subject to approval and acceptance by Seller. A written acknowledgement sent to Buyer of orders so approved shall constitute such acceptance by Seller. Seller may at any time alter or suspend credit, refuse shipment, or cancel unfulfilled orders when, in Seller's opinion, the financial condition of Buyer or the status of Buyer's account warrants it, or when delivery is delayed by fault of Buyer or Buyer is delinquent in any payment. No order accepted by Seller will be subject to cancellation, termination, suspension, change, reduction, cutback or any other modifications by Buyer except with Seller's prior written consent. Any such modifications may be subject to a change as determined by Seller. THE MINIMUM ORDER IS \$100.00 NET PRICE (U.S. Funds). Open account terms are extended to firms with established credit at APW Wyott Food Service Equipment Company ("APW Wyott"). If Buyer wishes to establish an open account, it should call the APW Wyott Manufacturer's Representative in its area and request a credit application. If Buyer's initial order is urgent, it should include a cashier's check with its completed application and initial order. Buyer's completed credit application will then be processed. Possession of APW Wyott Price List(s) does not constitute an offer to sell.

3. Payments

Payments should be mailed to APW Wyott: 29712 Network Place, Chicago, IL 60673-1297

4. Standard Case

All merchandise is sold in case lots only. There will be a \$10.00 net additional charge for each broken case.

5. Same Day Service

Seller will accommodate requests for same day service on orders placed by 10:00 a.m. CST.

6. Cancellation

Orders may be cancelled or deliveries deferred only upon the condition that the Buyer assumes immediate liability for and makes prompt payment to Seller of all expenses incurred, charges for commitments made by Seller, profit on work in process and contract value of items completed and ready for shipment. If the product is already in process of being produced or already made, the order cannot be cancelled.

7. Delivery

Shipment schedules are approximate only and are as accurate as present conditions permit. Seller assumes no responsibility or liability for failure or delay in making delivery or otherwise performing hereunder when such failure or delay is due to any cause beyond its control and without its fault or negligence. If for any reason Seller's supply of products ordered hereunder is caused to be limited, Seller shall have the right to prorate the supply in such manner as it, in its discretion, shall determine. Delivery to a common carrier shall constitute delivery to Buyer and all risk of loss or damage in transit shall be borne by Buyer. If, because of Buyer's inability to take delivery, the materials or equipment are not shipped, Seller may have them stored for Buyer at Buyer's expense, risk and account, and for all other purposes they shall be considered "shipped." Lift gate charge \$70.00. Inside delivery \$75.00. Delivery services are normally available anywhere within the 48 contiguous states.

8. Partial Deliveries

Seller may make partial deliveries which Buyer shall accept and pay for at the prices acknowledged upon maturity of bills. If any part of the order is not in accordance with the order, the remaining part of the order and Buyer's obligation hereunder shall not be affected.

9. Packaging

All items sold hereunder shall be packed or crated and shipped in accordance with Seller's best judgment. Any special packing, crating, or shipping instructions of Buyer must be noted on Buyer's original order in accordance with Seller's best judgment. Any special packaging, crating, or shipping instructions of Buyer must be noted on Buyer's original order and acknowledged by Seller.

10. Inspection

Buyer shall inspect all items upon arrival and shall give written notice to Seller within ten (10) days of receipt of any claim for shortage or non-conformance with the terms hereof. If Buyer shall fail to give such notice, all items shall be deemed to be conforming, and Buyer shall be bound to accept and pay for all items in accordance with the Terms hereof. If damage has occurred, it should be noted on the freight bill and claim filed by Buyer immediately with the carrier. Although APW Wyott takes special care to insure the safe arrival of merchandise, Seller's responsibility for damage ceases when shipment is accepted by the carrier. APW WYOTT CANNOT FILE THE FREIGHT DAMAGE CLAIM FOR THE BUYER.

11. Returns

APW Wyott has a Return Policy for Standard Stocking Products and a Policy for Non-Standard "Custom" Products requested by the Customer. Return Material Authorization (RMA) requests must be submitted within 30 days from date of invoice. In all cases, APW Wyott will refuse any returned goods that do not have prior APW Wyott approval and therefore, do not bear an APW Wyott Return Material Authorization (RMA) number. This RMA number will remain valid for sixty (60) days. Goods returned after this sixty (60) day period will be refused. Approved returned goods must be shipped prepaid. An authorized APW Wyott Customer Service Representative will alert Buyer as to the correct return address.

Approved Standard Stocking Products that are returned will be credited at invoice less 25% restocking charge and less outbound freight. Goods must be returned either in the original APW Wyott unopened box or returned unused and repacked in the original APW Wyott box using original APW Wyott packing materials.

Non Standard Custom Products are either Returnable (but with a 25% or \$50 minimum, whichever is higher, restocking charge to cover cost of re-work and parts) or Non-Refundable (not convertible or sellable to other customers). Catalog items which have been modified by addition of available options are returnable with a 50% restocking fee to cover cost of re-work and parts. Items that are eligible for return include Non Standard Food Wells, Calrod Overhead Warmers over 54", any Double or Lighted Overhead Warmer, and Radiant Black or Ceramic Overhead Warmer. Cancellation of order is not allowed 4-5 working days before the shipment due date. Buyer will be subject to a 50% charge if the equipment has been produced.

Non-Returnable Goods (Not convertible or sellable to other customers) may not be returned or cancelled once the product is planned and parts have been acquired. In some cases, a non-refundable deposit will be required. Non Returnable Custom Products include but is not limited to all Mobile Lowerators® and Rack Dispensers, any product with added decals or laminate, non standard or Oval Lowerator® Tubes, and some Export Voltage Products.

12. Repairs

Alterations and Modifications Any repairs made to products shipped by Seller shall be at the expense of the Buyer unless specifically authorized in writing by the Seller. Alterations or modifications to the product involving welding, brazing, soldering, drilling or machining by the Buyer is not permitted or approved by the Seller without specific authorization in writing by the Seller. Seller disclaims any and all liability and responsibility for any unauthorized alteration or modification by the Buyer or an unauthorized service representative which will void the warranty immediately.

13. Patent Indemnity

Buyer shall indemnify, defend and hold harmless Seller and its directors, officers, agents and employees against all loss, liability and claims for damages or profits, including all reasonable costs and expenses incurred by Seller in connection therewith, arising from any claim that the goods infringe any patents, copyrights, trademarks or claims or allegations of misappropriation of designs, proprietary data, trade secrets or any other intellectual property right of any person with respect to all goods manufactured either in whole or in part in accordance with Buyer's specifications. Upon receipt of notice from Seller of such alleged infringement, Buyer shall defend any action or claim of such infringement at its own expense.

14. Terms/Shipments

Terms are 1% - 10, net 30 days from date of invoice, F.O.B. Seller's dock unless otherwise expressly stated in writing by Seller. Late charges of up to two percent (2%) per month plus costs of collection will be assessed on past due invoices.

15. Taxes

Any taxes or other governmental charges upon production, sale and/or shipment of merchandise sold hereunder, now imposed by federal, state or municipal authorities, or hereafter becoming effective, including sales and use tax imposed as a result of Buyer requesting shipment direct to its customer in another state, shall be added to the prices provided by APW Wyott and shall be paid by the Buyer. Buyer is responsible for providing to APW Wyott valid sales tax resale or exempt certificates for all states in which Buyer is licensed.

16. Credits

Seller will only consider credits on which the claim has been initiated within twelve (12) months of the date of shipment.

Terms & Conditions

17. GENERAL

- a. No items to be furnished hereunder shall be exported by Buyer or by any customer of Buyer unless Seller is first notified in writing of the intention to so export and all applicable regulations and licenses are complied with and obtained by Buyer or its customer.
- b. Seller reserves the right to make changes in design at any time without incurring any obligation to make such changes in any items previously purchased, whether or not delivered.
- c. Seller expressly disclaims application of any Government procurement regulations in connection with any items to be furnished hereunder unless expressly agreed to in writing by an authorized representative of Seller.
- d. Seller hereby certifies that the goods described herein of its manufacture will be produced in compliance with all applicable requirements of Sections 6, 7 and 12 of the Fair Labor Standards Act, as amended, and all orders of United States Department of Labor issued under Section 14 thereof. Seller further certifies that it is in compliance with the Equal Employment Opportunity clause in Section 202, paragraph 1 through 7 of Executive Order 11246, as amended, relative to equal employment opportunity and the implementing Rules and Regulations of the Office of Federal Contract Compliance.
- e. Seller is not responsible for typographical errors made in any of its publications or for stenographic or clerical errors made in preparation of quotations, sales orders, or acknowledgements. All such errors are subject to correction.
- f. This agreement shall be governed by the laws of the State of Texas.
- g. Seller's "Terms and Conditions" as set forth above shall govern this transaction and any inconsistent terms of Buyer wherever set forth and whether oral or written, shall not be binding upon Seller unless agreed to in writing by Seller. No waiver or exception to any of the hereinabove enumerated conditions or any of the special terms and provisions relating to these Terms and Conditions shall be binding upon Seller unless agreed to in writing by the Seller.

18. WARRANTY INFORMATION

APW Wyott warrants its equipment against defects in materials and workmanship, subject to the following conditions: This warranty applies to the original owner only and is not assignable.

Should any product fail to function in its intended manner under normal use within the limits defined in this warranty, at the option of APW Wyott such product will be repaired or replaced by APW Wyott or its Authorized Service Agency. APW Wyott will only be responsible for charges incurred or service performed by its Authorized Service Agencies. The use of other than APW Wyott Authorized Service Agencies will void this warranty and APW Wyott will not be responsible for such work or any charges associated with same. The closest APW Wyott Authorized Service Agency must be used.

This warranty covers products shipped into the 48 contiguous United States, Hawaii, metropolitan areas of Alaska and Canada. There will be no labor coverage for equipment located on any island not connected by roadway to the mainland.

The warranty covers on-site labor, parts and reasonable travel time and travel expenses of the authorized service representative up to (100) miles round trip, and (2) hours travel time.

TIME PERIOD:

All APW Wyott Equipment is warranted for one year for parts and one year for labor. Warranty is 18 months from ship date from factory or 12 months from date of install, whichever comes first. The Authorized Service Agency may, at their option, require proof of purchase. Parts replaced under this warranty are warranted for the unexpired portion of the original product warranty.

EXCEPTIONS:

- Gas/Electric cookline – Models GCBi, GCRBi, GGMI, GGTi, GHPI, EFi, EGi, EHPi – Three (2) Year Warranty on all component parts, except switches and thermostats. (2) Year Warranty on labor
- Heat Strips – Models FD, FDL, FDD, FDDL – Two (2) Year Warranty on element only – no labor second year.
- Glass Windows, Doors, Seals, Rubber Seals, Light Bulbs, Broiler Briquettes – 90-Day Material Only – no labor.
- Rock grates, cooking grates, burner shields, and fire boxes – 90 day Material only – no labor.
- AT Express Toaster and X*treme Toasters – 2 year warranty.
- HD Series Three (3) Year Warranty on Parts and Two (2) Year labor

In all cases, parts covered by extended warranty will be shipped FOB the factory after the first year.

PORTABLE CARRY-IN PRODUCTS

Equipment weighing over 70 lbs. or permanently installed will be serviced on-site as per the terms of this warranty. Equipment weighing 70 lbs. or under, and which is not permanently installed, i.e. with cord and plug, is considered portable and is subject to the following warranty handling limitations.

If portable equipment fails to operate in its intended manner on the first day of connection, or use, at APW Wyott's option or its Authorized Service Agency, it will be serviced on-site or replaced.

From day two through the conclusion of the warranty period, portable units must be taken to or sent prepaid to the APW Wyott Authorized Service Agency for in-warranty repairs. No mileage or travel charges are allowed on portable units after the first day of use. If the customer wants on-site service, they may receive same by paying the travel and mileage charges. Exceptions to this rule (1) countertop warmers and cookers, which are covered under the Enhanced Warranty Program, and (2) toasters or roller grills which have in-store service.

EXCLUSIONS:

The following conditions are not covered by warranty:

- Equipment failure relating to improper installation, improper utility connection or supply and problems due to ventilation.
- Equipment that has not been properly maintained, calibration of controls, adjustments, damage from improper cleaning and water damage to controls.
- Equipment that has not been used in an appropriate manner, or has been subject to misuse or misapplication, neglect, abuse, accident, alteration, negligence, damage during transit, delivery or installation, fire, flood, riot, or act of God.
- Equipment that has had the model number or serial number removed or altered.

If the equipment has been changed, altered, modified or repaired by other than an Authorized Service Agency during or after the warranty period, then APW Wyott shall not be liable for any damages to any person or to any property which may result from the use of the equipment thereafter.

This warranty does not cover services performed at overtime or premium labor rates. Should service be required at times which normally involve overtime or premium labor rates, the Buyer shall be charged for the difference between normal service rates and such premium rates. APW Wyott does not assume any liability for extended delays in replacing or repairing any items beyond its control. In all cases, the use of other than APW Wyott authorized OEM replacement parts will void this warranty. This equipment is intended for commercial use only. Warranty is void if equipment is installed in other than commercial application.

WATER QUALITY REQUIREMENTS

Water supply intended for a unit that has in excess of 3.0 grains of hardness per gallon (GPG) must be treated or softened before being used. Water containing over 3.0 GPG will decrease the efficiency and reduce the operating life of the unit.

Note: Product failure caused by liming or sediment buildup is not covered under warranty.

THE FOREGOING WARRANTIES ARE EXCLUSIVE AND ARE GIVEN AND ACCEPTED IN LIEU OF ANY AND ALL OTHER WARRANTIES, EXPRESSED OR IMPLIED, INCLUDING, WITHOUT LIMITATION, ANY IMPLIED WARRANTIES OF MERCHANTABILITY OR FITNESS FOR A PARTICULAR PURPOSE AND ALL OTHER REMEDIES. THESE ARE THE ONLY REMEDIES OF BUYER FOR ANY BREACH OF WARRANTY OR ANY OTHER CLAIM. SELLER'S TOTAL LIABILITY ARISING OUT OF THE WARRANTIES OR CLAIM OF NEGLIGENCE, OR OTHERWISE, SHALL NOT IN ANY CASE EXCEED THE COST PAID BY BUYER TO SELLER FOR THE MATERIALS AND IN NO CASE SHALL SELLER BE LIABLE TO BUYER OR ANY THIRD PARTY FOR ANY INCIDENTAL, CONSEQUENTIAL OR SPECIAL DAMAGES.

Buyer agrees to indemnify and hold Seller harmless from all claims, demands and costs, including reasonable attorney fees, made by third parties against Seller relating to Buyer's use or installation of the products, and to pay any costs and expenses incurred by Seller to enforce Buyer's obligations, including, without limitation, the costs of collection for any unpaid amounts owed to Seller by Buyer.

Sales Representatives

ALABAMA

Carman Girard Associates
3157 Presidential Dr. Ste. 200
Atlanta, GA 30340
Ph: (770) 457-6548
Fx: (770) 451-2091
Toll Free: (800) 969-3299
dgirard@carmangirard.com

ALASKA

MarkeTeam
1115 West 36th Street
Vancouver, WA 98660
Ph: (360) 696-3984
Fx: (360) 693-0192
info@marketeamnw.com

ARIZONA

Ignite Foodservice Solutions
16830 South 23rd St
Phoenix, AZ 85048
Ph: (877) 835-0122
Fx: (303) 433-3290
Mark Shaw
mark@ignitefoodservice.com

ARKANSAS

VELKEY & ASSOCIATES
232 Market Street
Flowood, Mississippi 39232
PH: 601-977-0620
FX: 601-957-2059
marilyn.velkey@usa.net

CALIFORNIA

Restaurant Equipment Professionals
26046 Eden Landing Rd, Ste. 3
Hayward CA 94545
Ph: (510) 785-5566
Fx: (510) 785-5588
info@restequippro.com

Fredco Mfrs' Reps

9661 Irvine Center Dr
Irvine CA 91618-4652
Ph: (949) 788-7788
Fx: (949) 788-9222
www.fredcoreps.com
Southern California

COLORADO

Ignite Foodservice Solutions
3700 Havana St #208
Denver, CO 80239
Ph: (877) 835-0122
Fx: (303) 433-3290
mail@ignitefoodservice.com

CONNECTICUT

Butkevich Associates
PO Box 73, 2 Main Street
Avon, MA 02322
Ph: (508) 584-1818
Fx: (508) 583-8401
maria@butkevich.com
All zips except 066, 068 & 069

TD Marketing

84 Mayfield Ave.
Edison, NJ 08837
Ph: (732) 339-3266
Fx: (732) 902-2636
www.tdmarketing.com
fdoyle@tdmarketingco.com
Zips 066, 068 & 069

DELAWARE

Barsky-Fleming
2080 Wheatshaf Lane
Philadelphia, PA 19124
Ph: (215) 289-5411
Fx: (215) 289-5420
info@bfm1.com

DISTRICT OF COLUMBIA

Equipment Solutions, Inc
45965 Nokes Blvd. Suite 110
Sterling, Va 20166
Ph: (703) 242-9710
Fax: (703) 242-9717
bstat@esinc.us

FLORIDA

Florida Agents
1444 20th Street North
St. Petersburg, FL 33713
Ph: (727) 572-5200
Fx: (727) 823-7766
greg@floridaagents.com

Carman Girard Associates
3157 Presidential Dr. Ste. 200
Atlanta, GA 30340
Ph: (770) 457-6548
Fx: (770) 451-2091
Toll Free: (800) 969-3299
dgirard@carmangirard.com
Panhandle

GEORGIA

Carman Girard Associates
3157 Presidential Dr. Ste. 200
Atlanta, GA 30340
Ph: (770) 457-6548
Fx: (770) 451-2091
Toll Free: (800) 969-3299
dgirard@carmangirard.com

HAWAII

MarkeTeam
1115 West 36th Street
Vancouver, WA 98660
Ph: (360) 696-3984
Fx: (360) 693-0192
info@marketeamnw.com

IDAHO

MarkeTeam
1115 West 36th Street
Vancouver, WA 98660
Ph: (360) 696-3984
Fx: (360) 693-0192
info@marketeamnw.com

ILLINOIS

Cassidy's Proline
205 Eisenhower Lane South
Lombard, IL 60148
Ph: (630) 627-7353
Fx: (630) 628-3529
prolinerep@aol.com
Northern/Central IL

Paragon Marketing
130-C Clarkson Executive Pkwy.
Ellisville, MO 63011
Toll Free: (866) 394-7194
Ph: (636) 394-5548
Fx: (636) 394-7114
joeparagon@sbcglobal.net
Southern IL

INDIANA

SESCO
15901 Commerce Park Dr.
Brook Park, OH 44142
Toll Free: (800) 222-0558
Fx: (800) 251-7717
www.sesco.biz
billw@sesco.biz
Except Northwest IN

Cassidy's Proline
205 Eisenhower Lane South
Lombard, IL 60148
Ph: (630) 627-7353
Fx: (630) 628-3529
prolinerep@aol.com
Northwest IN

IOWA

Paragon Marketing
10915 Eicher Drive
Lenexa, KS 66219
Ph: (913) 469-6868
Fx: (913) 469-6870
sales@paragonmarketing.net
Western IA

Goode Company
130-C Clarkson Executive Pkwy
Ellisville, MO 63011
Toll Free: (866) 394-7114
Ph: (636) 394-5548
Fx: (636) 394-7114
Eastern IA

KANSAS

Paragon Marketing
10915 Eicher Drive
Lenexa, KS 66219
Ph: (913) 469-6868
Fx: (913) 469-6870
sales@paragonmarketing.net

KENTUCKY

SESCO
15901 Commerce Park Dr.
Brook Park, OH 44142
Toll Free: (800) 222-0558
Fx: (800) 251-7717
www.sesco.biz
billw@sesco.biz

LOUISIANA

VELKEY & ASSOCIATES
232 Market Street
Flowood, Mississippi 39232
PH: 601-977-0620
FX: 601-957-2059
marilyn.velkey@usa.net

MAINE

Butkevich Associates
PO Box 73, 2 Main Street
Avon, MA 02322
Ph: (508) 584-1818
Fx: (508) 583-8401
maria@butkevich.com

MARYLAND

Equipment Solutions, Inc
45965 Nokes Blvd. Suite 110
Sterling, Va 20166
Ph: (703) 242-9710
Fax: (703) 242-9717
bstat@esinc.us

MASSACHUSETTS

Butkevich Associates
PO Box 73, 2 Main Street
Avon, MA 02322
Ph: (508) 584-1818
Fx: (508) 583-8401
maria@butkevich.com

MICHIGAN

Stiefel Associates, Inc.
4929 Contec Dr.
Lansing, MI 48910
Ph: (517) 393-3019
Fx: (517) 393-3023
Toll Free: (800) 860-4887
john@stiefelrep.com

Davis Assoc., Inc
W184S8372 Challenger Dr.
Muskego, WI
Ph: (262) 679-9510
Fx: (262) 679-5441
customerservice@davisassoc.com

MINNESOTA

Metcalfe & Associates, Inc.
8557 Wyoming Ave. N/Ste 5
Minneapolis, MN 55445
Ph: (763) 425-7880
kim@metcalfeassociates.com

MISSISSIPPI

VELKEY & ASSOCIATES
232 Market Street
Flowood, Mississippi 39232
PH: 601-977-0620
FX: 601-957-2059
marilyn.velkey@usa.net

MISSOURI

Paragon Marketing
10915 Eicher Drive
Lenexa, KS 66219
Ph: (913) 469-6868
Fx: (913) 469-6870
sales@paragonmarketing.net
Western MO

Goode Company
130-C Clarkson Executive Pkwy
Ellisville, MO 63011
Toll Free: (866) 394-7114
Ph: (636) 394-5548
Fx: (636) 394-7114
Eastern MO

MONTANA

MarkeTeam
1115 West 36th Street
Vancouver, WA 98660
Ph: (360) 696-3984
Fx: (360) 693-0192
info@marketeamnw.com

NEBRASKA

Paragon Marketing
10915 Eicher Drive
Lenexa, KS 66219
Ph: (913) 469-6868
Fx: (913) 469-6870
sales@paragonmarketing.net

Sales Representatives

NEVADA

Restaurant Equipment Professionals
26046 Eden Landing Rd, Ste. 3
Hayward CA 94545
Ph: (510) 785-5566
Fx: (510) 785-5588
info@restequipro.com

Fredco Mfrs' Reps
Irvine CA 92618-4652
Ph: (949) 788-7788
Fx: (949) 788-9222
www.fredcoreps.com
Southern Nevada

NEW HAMPSHIRE

Butkevich Associates
PO Box 73, 2 Main Street
Avon, MA 02322
Ph: (508) 584-1818
Fx: (508) 583-8401
maria@butkevich.com

NEW JERSEY

TD Marketing
84 Mayfield Ave.
Edison, NJ 08837
Ph: (732) 339-3266
Fx: (732) 902-2636
www.tdmarketing.com
fdoyle@tdmarketingco.com
Zips 066, 068 & 069

Barsky-Fleming

2080 Wheatshaf Lane
Philadelphia, PA 19124
Ph: (215) 289-5411
Fx: (215) 289-5420
info@bfm1.com
Zips 080-087

NEW MEXICO

Ignite Foodservice Solutions
6608 Tesoro Place NE
Albuquerque, NM 87113
Ph: (877) 835-0122
Fx: (877) 904-3078
Russell Shupe
russell@ignitefoodservice.com

NEW YORK

TD Marketing
84 Mayfield Ave.
Edison, NJ 08837
Ph: (732) 339-3266
Fx: (732) 902-2636
www.tdmarketing.com
fdoyle@tdmarketingco.com

Jon Travers

Division of TD Marketing
84 Mayfield Ave.
Edison, NJ 08837
Ph: (315) 469-7104
jatravers1@netzero.net
Upstate New York

NORTH CAROLINA

Carolina Food Service
9650 Strickland Road
Ste. 103-108
Raleigh, NC 27615
Ph: (919) 518-0873
Fx: (919) 518-0411
frank@carolinafoodservicesolutions.com

NORTH DAKOTA

Metcalfe & Associates, Inc.
8557 Wyoming Ave. N/Ste 5
Minneapolis, MN 55445
Ph: (763) 425-7880
kim@metcalfeassociates.com

OHIO

SESCO
15901 Commerce Park Dr.
Brook Park, OH 44142
Toll Free: (800) 222-0558
Fx: (800) 251-7717
www.sesco.biz
billw@sesco.biz

OKLAHOMA

APW Customer service
Customer Service Western Region
1307 N. Watters Rd STE 180
Allen, TX 75013
Ph: 972-908-6100
Toll Free: 800-527-2100
Fx: 214-565-0976
western@standexcsg.com

OREGON

MarkeTeam
1115 West 36th Street
Vancouver, WA 98660
Ph: (360) 696-3984
Fx: (360) 693-0192
info@marketeamnw.com

PENNSYLVANIA

SESCO
15901 Commerce Park Dr.
Brook Park, OH 44142
Toll Free: (800) 222-0558
Fx: (800) 251-7717
www.sesco.biz
billw@sesco.biz
West PA

Barsky-Fleming

2080 Wheatshaf Lane
Philadelphia, PA 19124
Ph: (215) 289-5411
Fx: (215) 289-5420
info@bfm1.com
East PA

RHODE ISLAND

Butkevich Associates
PO Box 73, 2 Main Street
Avon, MA 02322
Ph: (508) 584-1818
Fx: (508) 583-8401
maria@butkevich.com

SOUTH CAROLINA

Carolina Food Service
9650 Strickland Road
St 103-108
Raleigh, NC 27615
Ph: (919) 518-0873
Fx: (919) 518-0411
frank@carolinafoodservicesolutions.com

SOUTH DAKOTA

Metcalfe & Associates, Inc.
8557 Wyoming Ave. N/Ste 5
Minneapolis, MN 55445
Ph: (763) 425-7880
kim@metcalfeassociates.com

TENNESSEE

VELKEY & ASSOCIATES
232 Market Street
Flowood, Mississippi 39232
PH: 601-977-0620
FX: 601-957-2059
marilyn.velkey@usa.net
Western TN

Carman Girard Associates

3157 Presidential Dr. Ste. 200
Atlanta, GA 30340
Ph: (770) 457-6548
Fx: (770) 451-2091
Toll Free: (800) 969-3299
dgirard@carmangirard.com
Middle & East TN

TEXAS

APW Customer service
Customer Service Western Region
1307 N. Watters Rd STE 180
Allen, TX 75013
Ph: 972-908-6100
Toll Free: 800-527-2100
Fx: 214-565-0976
western@standexcsg.com
All of Texas except El Paso

Ignite Foodservice Solutions

6608 Tesoro Place NE
Albuquerque, NM 87113
Ph: (877) 835-0122
Fx: (877) 904-3078
Russell Shupe
russell@ignitefoodservice.com
El Paso

UTAH

Ignite Foodservice Solutions
6951 North Bear Spring Circle
Mount Green, UT 84050
Ph: (877) 835-0122
Fx: (303) 433-3290
Russ Middleton
russ@ignitefoodservice.com

VERMONT

Butkevich Associates
PO Box 73, 2 Main Street
Avon, MA 02322
Ph: (508) 584-1818
Fx: (508) 583-8401
maria@butkevich.com

VIRGINIA

Equipment Solutions, Inc
45965 Nokes Blvd. Suite 110
Sterling, Va 20166
Ph: (703) 242-9710
Fax: (703) 242-9717
bstat@esinc.us

WASHINGTON

MarkeTeam
1115 West 36th Street
Vancouver, WA 98660
Ph: (360) 696-3984
Fx: (360) 693-0192
info@marketeamnw.com

WEST VIRGINIA

SESCO
15901 Commerce Park Dr.
Brook Park, OH 44142
Toll Free: (800) 222-0558
Fx: (800) 251-7717
www.sesco.biz
billw@sesco.biz

WISCONSIN

Davis Assoc., Inc
W184S8372 Challenger Dr.
Muskego, WI
Ph: (262) 679-9510
Fx: (262) 679-5441
customerservice@davisassoc.com

WYOMING

Ignite Foodservice Solutions
3700 Havana St #208
Denver, CO 80239
Ph: (877) 835-0122
Fx: (303) 433-3290
mail@ignitefoodservice.com

Canada

Chesher Equipment Ltd
6599 Kitimat Rd. Unit #2
Mississauga, Ontario
Canada L5N4J4
Ph: +1 (905) 363-0309
Toll Free: (800) 668-8765
Fax: +1 (905) 363-0426
info@chesher.com
www.chesher.com

UNITED KINGDOM & IRELAND

Euro Catering Equipment
3-4 Turnpike Close
Lutterworth
Leicestershire LE17 4YB
Ph: +44 01455 559969
Managing Director – Tim Charlton

CONTINENTAL EUROPE, ASIA AND PACIFIC REGIONS

Including Australia, Central & South America, Mexico, Middle East and Africa
Greenfield WorldTrade, Inc.
3355 Enterprise Ave, Suite 160
Fort Lauderdale, FL 33331
Ph: +1 954 202 7336
Vice President – Jonathan Varnos
sales@greenfieldworld.com



UL Listed



CSA Listed



NSF Listed



European Conformity



UL Listed to applicable UL and Canadian standards



UL Recognized Component



CSA Certified to applicable U.S. gas standards



ETL Sanitation Listed

Intertek



UL Classified to applicable NSF standard



Intertek ETL Listed



CSA Listed to applicable Canadian gas standards



Energy Star



Plug Configurations

120V Models

208/240V Models



NEMA 5-15P

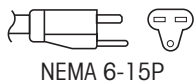

NEMA 6-15P



NEMA 5-20P

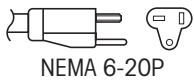

NEMA 6-20P

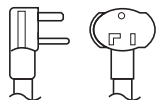

NEMA 5-30P

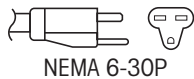

NEMA 6-30P

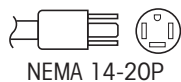

NEMA 14-20P

Common Conversion Formulas

Watts x Volts = Amps (Single Phase Only)

Inches x 2.54 = Centimeters

Pounds x 0.454 = Kilograms

(°Fahrenheit - 32) x .56 = °Celsius

Gallons x 3.785 = Liters



The Standex Culinary Development Center is a state-of-the-art culinary facility located in Allen, Texas. It is fully equipped with a wide range of products from all of our brands. The Standex Culinary Development Center was designed to accommodate the needs of our stakeholders by providing the tools necessary for creating new menu items along with training and testing on equipment. For details on reserving the Culinary Development Center, please contact your Standex representative.

APW *wyott*®

APW Wyott is part of the Standex Food Service Equipment Group,
along with other well-known cooking solutions including:



Customer Service: 800.527.2100

24-Hour Service Hotline: 800.733.2203 • servicegroup@standex.com

Replacement Parts: parts2@standex.com

Literature Requests: literature@standex.com

APW Wyott Food Service Equipment Company

1307 N. Watters Road, Suite 180 • Allen, TX 75013

Toll Free 800.527.2100 • Local 972.908.6100 • Fax 214.565.0976

www.apwwyott.com



youtube.com/user/StandexCSG